



AIRSTAGE™ V-II

Variable Refrigerant Flow System

Multi Air Conditioning System for Buildings

- Large Capacity Multi VRF System
- DC Inverter Control Compressor
- Long Piping System Design
- High Efficiency Refrigerant R410A



FUJITSU GENERAL LIMITED

Refrigerant
R410A

INVERTER

AIRSTAGE™ V-II

Variable Refrigerant Flow System

8, 10, 12HP



DIMENSIONS: H 1,690 X W 930 X D 765 (mm)

Newly designed compact outdoor unit

Smart and cutting edge design

Extensive lineup from 8HP to 48HP in 2HP increment

Connectable indoor unit capacity ratio up to 150%

High Efficiency Operating System

EER/COP has been significantly improved by unique inverter technology and refrigerant control technology.

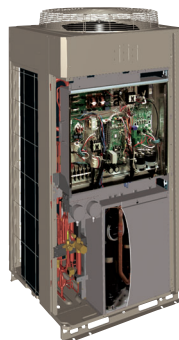

Installation Flexibility

Total pipe length of 1,000m and 150m actual pipe length. From small to large buildings, any application can be supported.

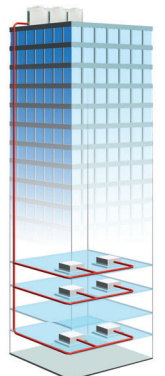

14, 16HP



DIMENSIONS: H 1,690 X W 1,240 X D 765 (mm)

CONTENTS

V-II Series Features

High Efficiency Operation	4
Design Versatility	6
High Reliability	8
Easy Installation	10
Comfort and Convenience	12
Easy Service & Maintenance	14

Outdoor Units

Lineup	16
Innovative Technology	18
Specifications	20
Dimensions	22

Indoor Units

Lineup	24
Compact Cassette	26
Cassette	28
Compact Duct	30
Low Static Pressure Duct	32
Duct	32
High Static Pressure Duct	34
Floor / Ceiling	36
Ceiling	38
Compact Wall Mounted	40
Wall Mounted	42

Controller

Control System	44
Wiring System	46
Comparison with Controllers	47
Wired Remote Controller	48
Simple Remote Controller	49
Wireless Remote Controller	50
IR Receiver Unit	51
IR Receiver Kit	51
Group Remote Controller	52
Touch Panel Controller	54
System Controller (Software)	56

Convertor & Adaptor

Network Convertor	58
Network Convertor for LONWORKS®	59
BACnet® Gateway (Software)	60
Signal Amplifier	61
External Switch Controller	61

Service & Monitoring

Service Tool (Software)	62
Web Monitoring Tool (Software)	64

Optional Parts

Compact Design

The outdoor unit size has been significantly reduced by optimizing of equipment. This allows for a reduction in the required installation area floor space.

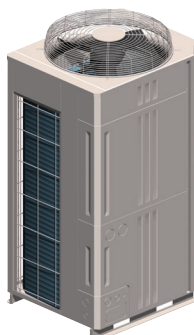

User Friendly Central Control

Diverse building air conditioning control functions can be controlled easily by central Airconditioning control.

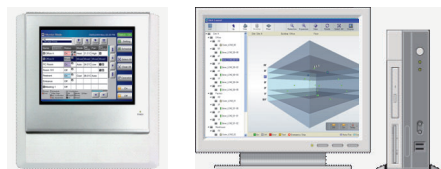

High Efficiency Operation

Advanced system considers high efficiency operation

High Efficiency

Significantly improved EER/COP

Significantly greater efficiency is realized by the use of a DC twin rotary compressor, inverter technology, and large heat exchanger.

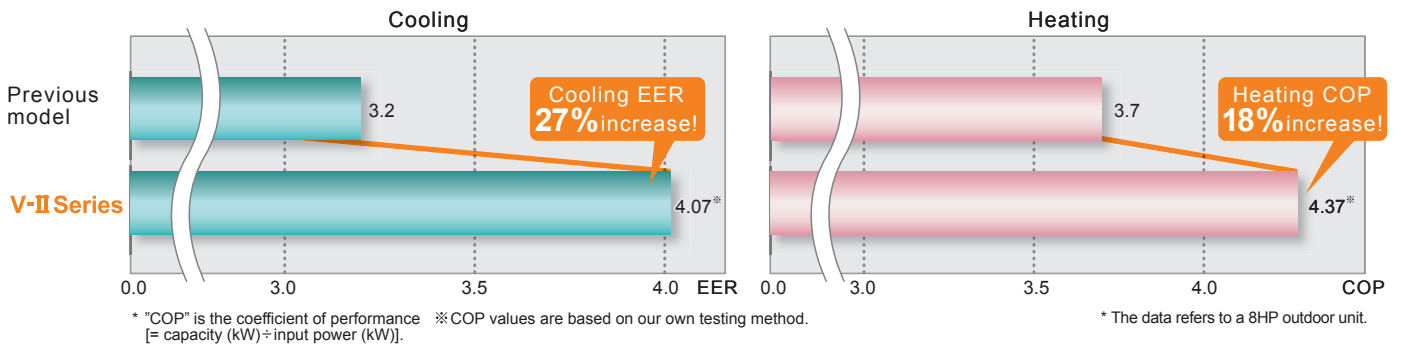

Energy saving technology that boosted operation efficiency

Power consumption has been reduced by 25% compared to previous models by using a compact and high performance DC fan motor.

High efficiency operation is realized by using a sine wave DC inverter control.

Significantly greater efficiency is realized by use of a large capacity DC twin rotary compressor with substantially increased refrigerant intake and compression efficiency.

Heat exchange efficiency is significantly improved by the introduction of a new 4-face heat exchanger that increases effective surface area.







Previous model → V-II Series
 Surface area 1.7 times!

In multiple outdoor unit installations, the unique front intake design improves airflow into the Heat Exchanger.



Energy efficiency combination

Choice of space saving or energy efficiency combinations

	[Space saving combination]		[Energy efficiency combination]	
[For 16HP]		→		18% energy saving !
[For 24HP]		→		12% energy saving !
[For 28HP]		→		10% energy saving !

(Comparison of Average COP)

Various energy saving features

Room temperature set point limitation

The minimum and maximum temperature range can be set giving further energy saving while considering the comfort of the occupants.

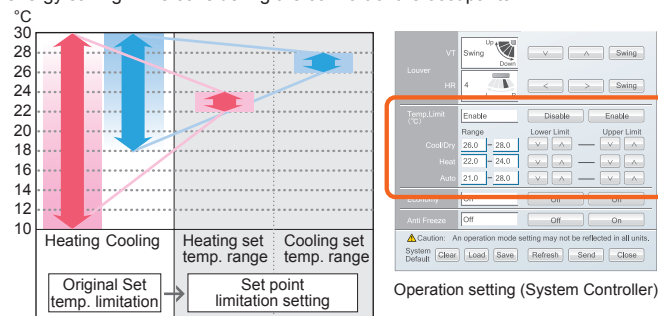

Peak cut operation

Operation capacity can be set in 4 steps for rated capability. The power consumption at peak is cut down and the maximum load is suppressed.

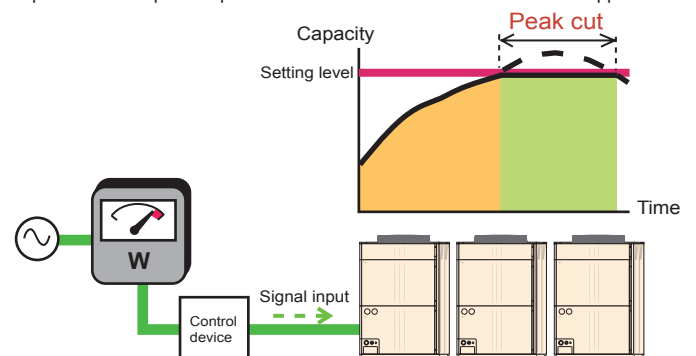

Auto-off timer

Each remote controller is equipped with an OFF timer function that automatically stops operation when a fixed time has elapsed from the start of operation. This prevents wasteful operation. (NB Except simple remote controller)

Economy operation

Economy operation can be set by remote controller. The temperature setting is offset automatically over a certain period of time.

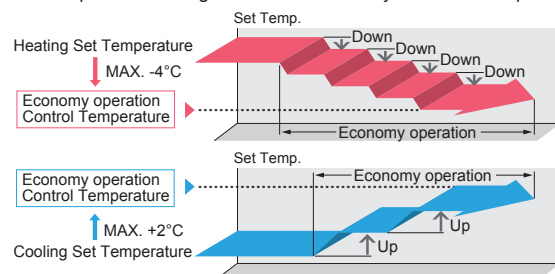

Design Versatility

V-II systems can be applied to a wide variety of Building applications due to the reduced outdoor unit size and piping length capabilities

Flexible and easy piping design

Overall piping length 1,000m

World's top class overall piping length of 1,000m allows for application in a wide variety buildings.

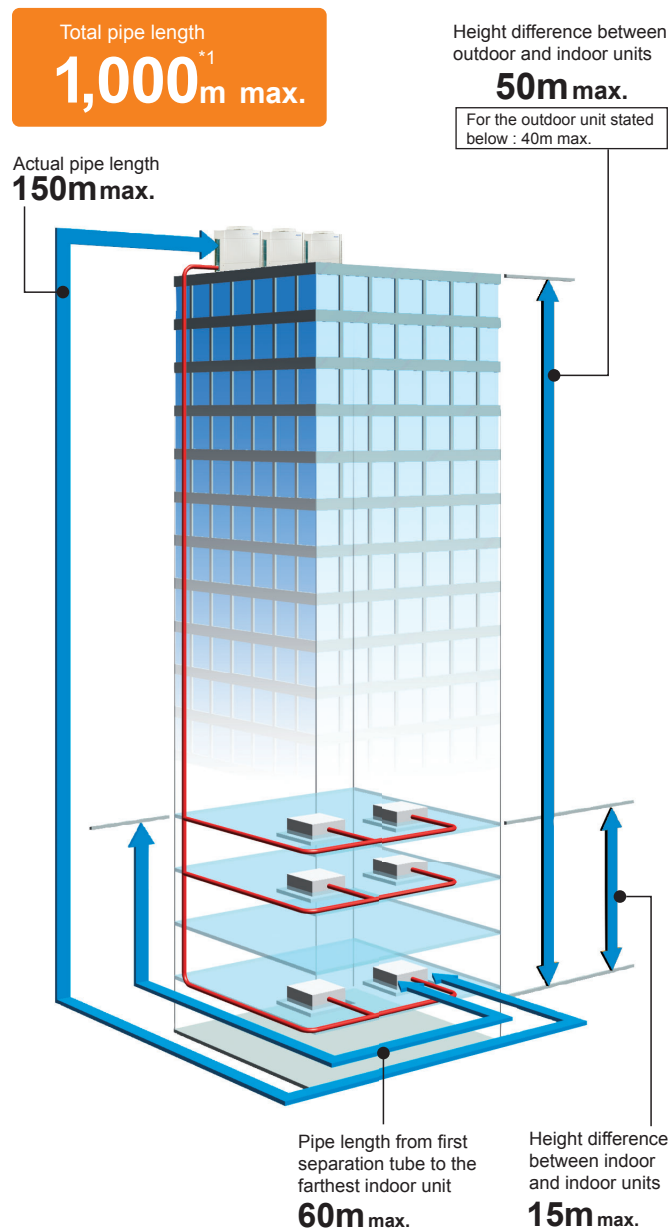

*1 Note : When there is 1 outdoor unit, the maximum is 700m.

High static pressure of 80Pa

The outdoor unit can have a condenser hood easily connected with a static pressure of 80Pa standard. This allows outdoor units to be installed within plant rooms in high rise buildings.

Powerful discharge with an external static pressure of 80Pa.

Previous model

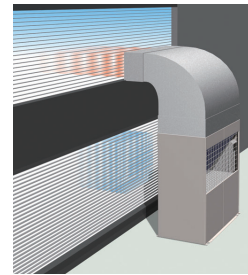

V-II Series

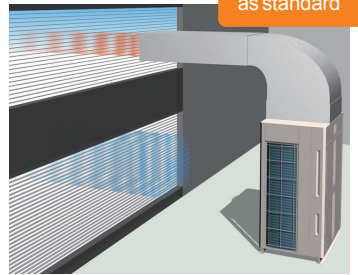

Large diameter fan and DC motor has been utilized allowing an external static pressure of 80Pa. This is approximately 2.6 times greater than the previous model.

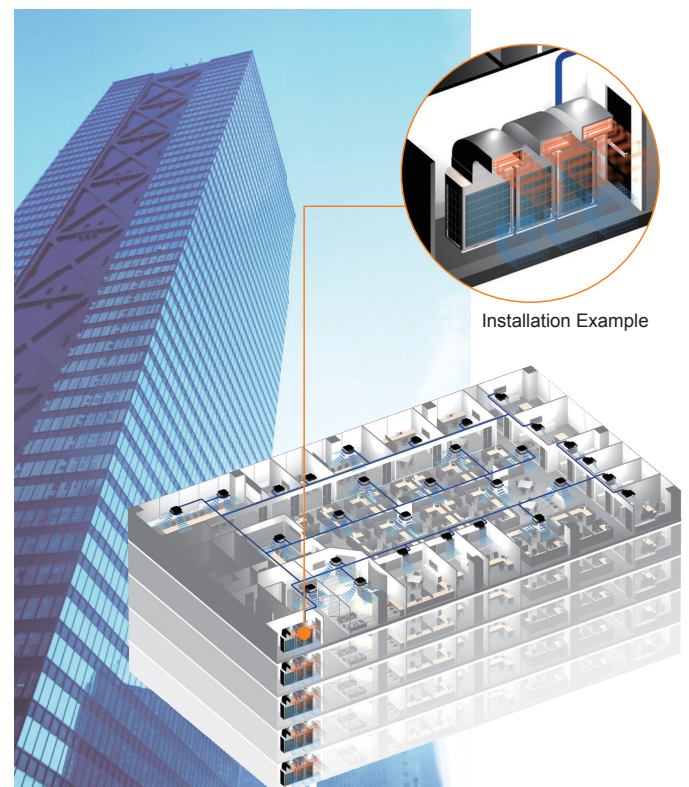

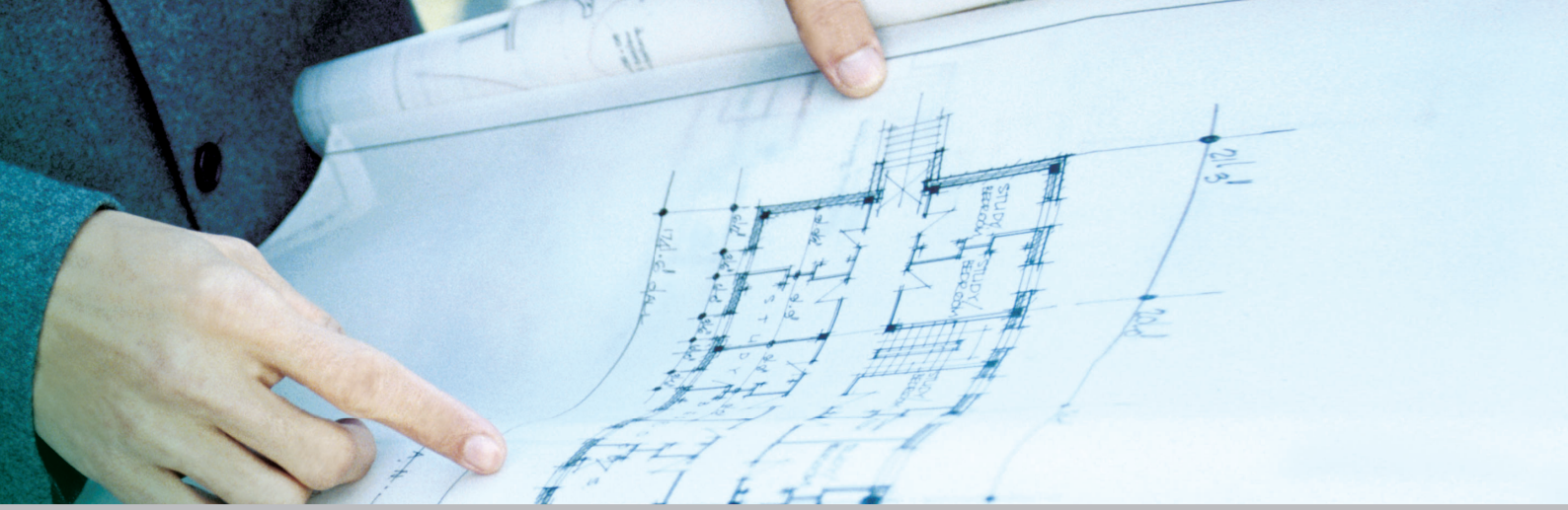

Space saving and compact size

Compact size has been achieved by significantly reducing the width of the outdoor units compared to previous models.

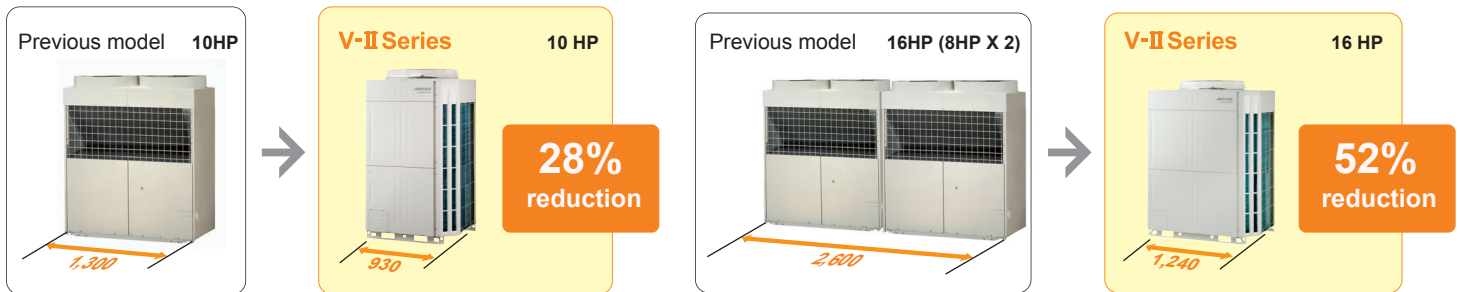

For 160HP

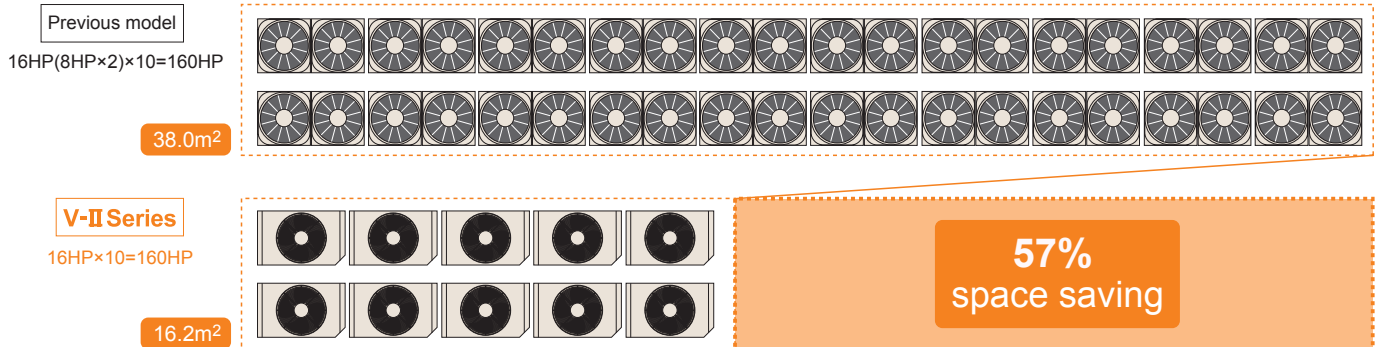

Wide operating range

Installation in extreme temperature conditions is possible due to an increase in operational range.

Cooling : -15°C~46°C

Heating : -20°C~21°C

(°C)

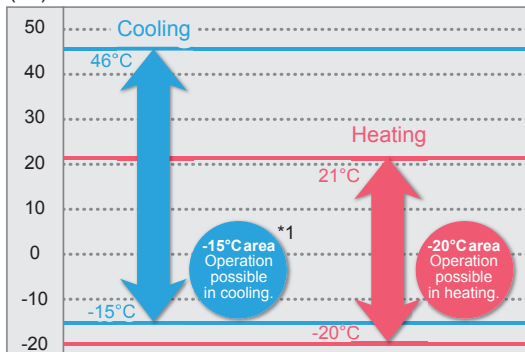

*1 Note : When a multiple outdoor unit connection is used, operating range is from -5°C to 46°C in cooling.

Various combinations

Various combination from 8HP to 48HP with 2HP increments. 11 types, 49 models of indoor units can be selected ranging from 2.2kW to 25kW in capacity. A maximum of 150% indoor unit connectable capacity.

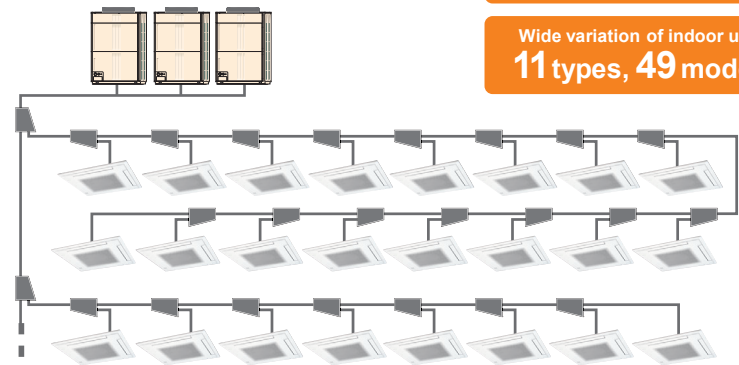

Connectable indoor unit capacity
Ratio up to 150%

Connectable indoor unit number
up to 48

Wide variation of indoor units
11 types, 49 models

Note : when indoor unit connected capacity is greater than 100%, individual indoor units will operate at a slightly lower capacity when maximum capacity is required.

High Reliability

High reliability considering long-term safety and confidence

Operating Rotation

Outdoor unit operating rotation

The compressor starting order is rotated so that the running time is shared.

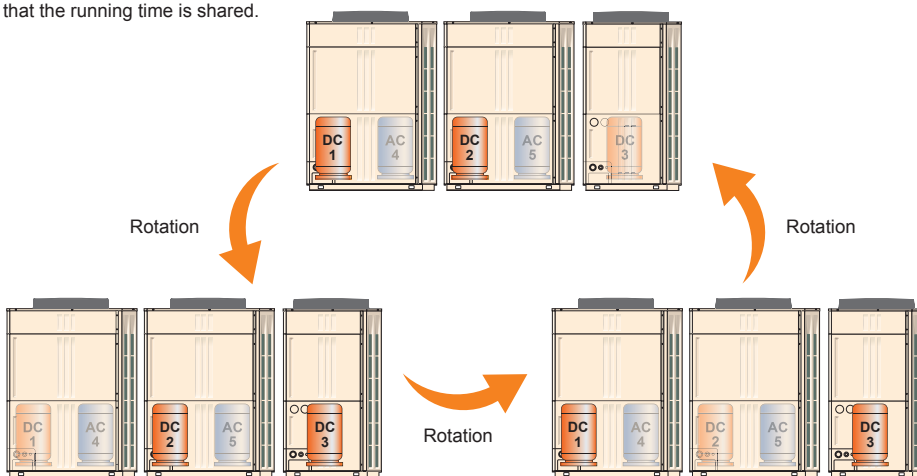

Note : The inverter compressors start in priority.
Operating rotation is alternated by the start / stop timing of the compressors



Continuous operation

Backup operation

If one of two compressors malfunctions, it will not affect the operation of the remaining outdoor units.

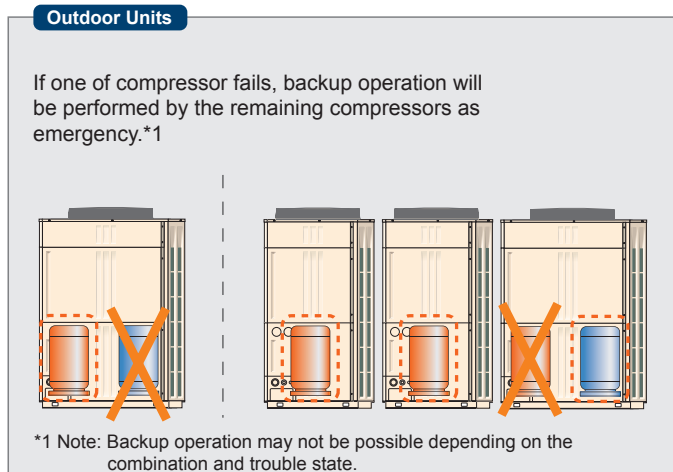

Indoor Units

Indoor unit continuous operation

Each indoor unit is controlled individually on the system network. This allows all indoor units to continue to operate unaffected even if an error might occur at any indoor unit's on the VRF system.

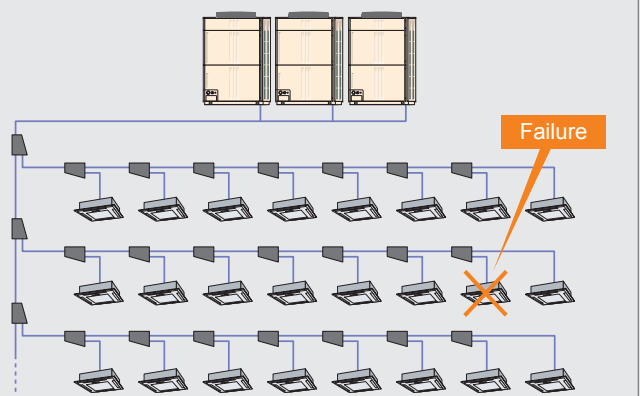



Corrosion treatment

■ Adoption of blue fin heat exchanger

Corrosion resistant of the heat exchanger has been improved by the introduction of blue fin treatment to the outdoor unit's heat exchanger.

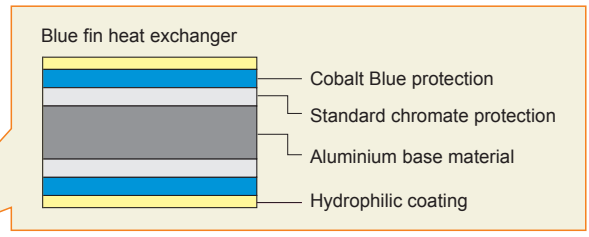
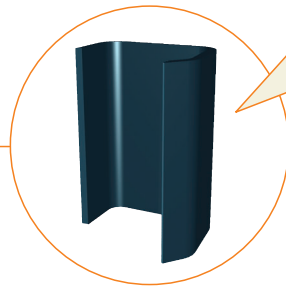

Remote monitoring

■ Remote monitoring over the internet

The Web Monitoring system allows you view system operation at all times over the internet ensuring trouble free operation.

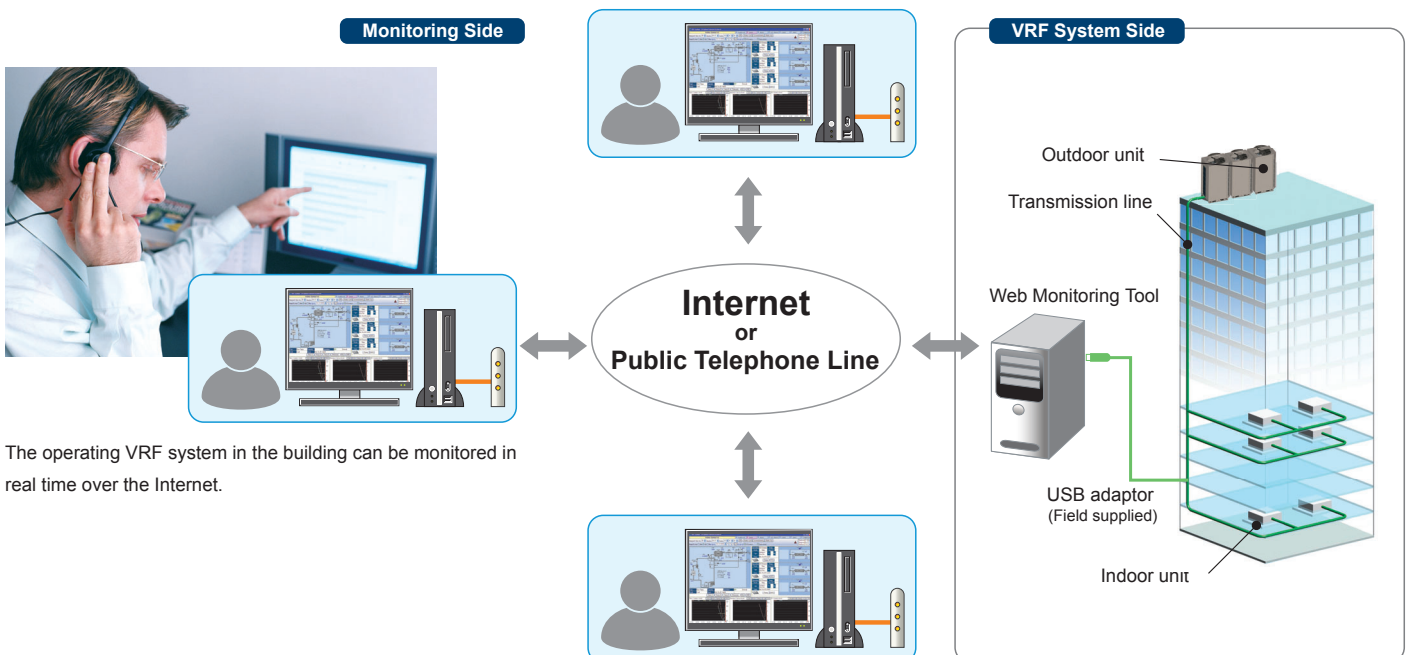

The operating VRF system in the building can be monitored in real time over the Internet.

Easy Installation

From transportation of the product to address setting for commissioning, significant improvements have been made which reduce the cost of installation.

Easily transported

■ Light weight

20% weight reduction
(Than Previous model)

Note: In the case of 14HP

■ Easily craned into position using lifting belt hooks

Design of outdoor unit allows for lifting straps to be used

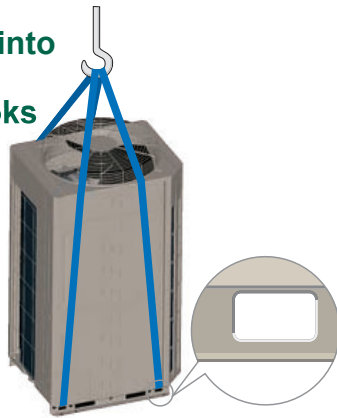

■ Can be transported in a small elevator

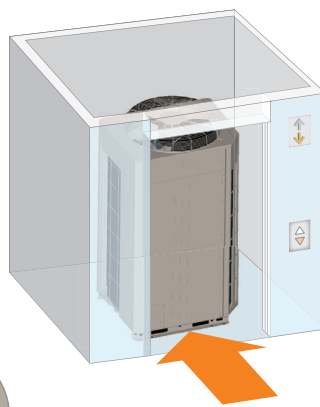

■ Transporting by forklift

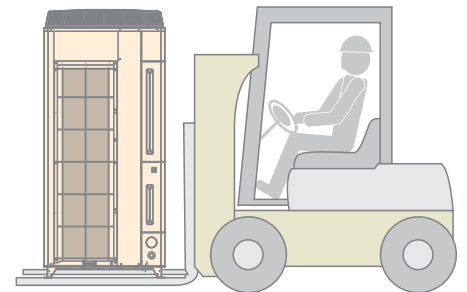

Transport with forklift is possible.

Simple wiring & piping work

■ Simple signal line connection

Installation is made easier as the communications wiring can be connected continuously to any component.

Up to maximum length 3,600m

V-II Series

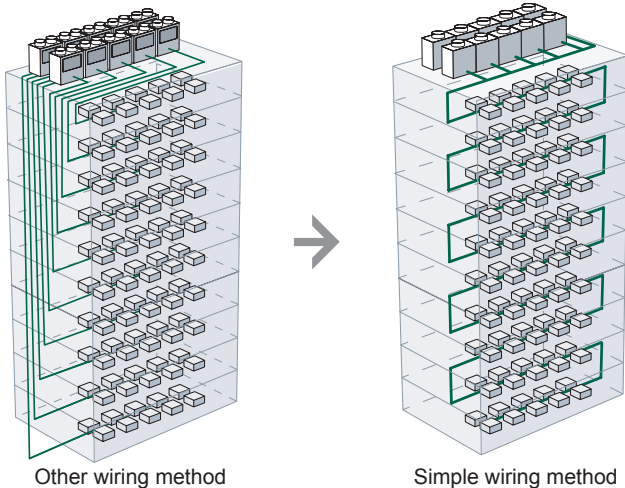

Note: In a multiple refrigerant system installation, Automatic addressing sequence cannot be initiated

■ Easy piping connection

The need for a oil equalization pipe as required on the previous model has been removed. The installation costs have been reduced by employing a Simple 2 pipe connection

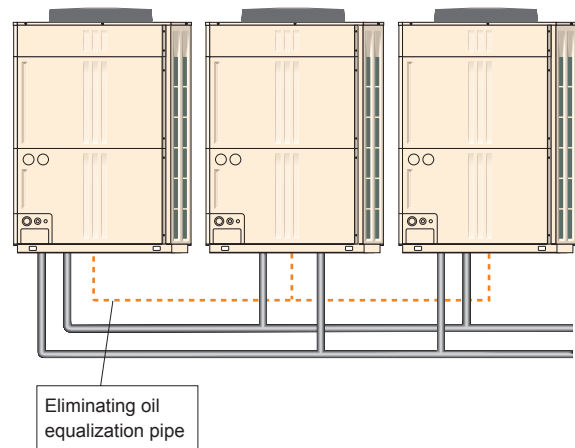



Easy setting operation

Automatic address setting

The address of each indoor unit can be automatically set by button switch of outdoor unit.

Press the pushbutton switch of outdoor unit.

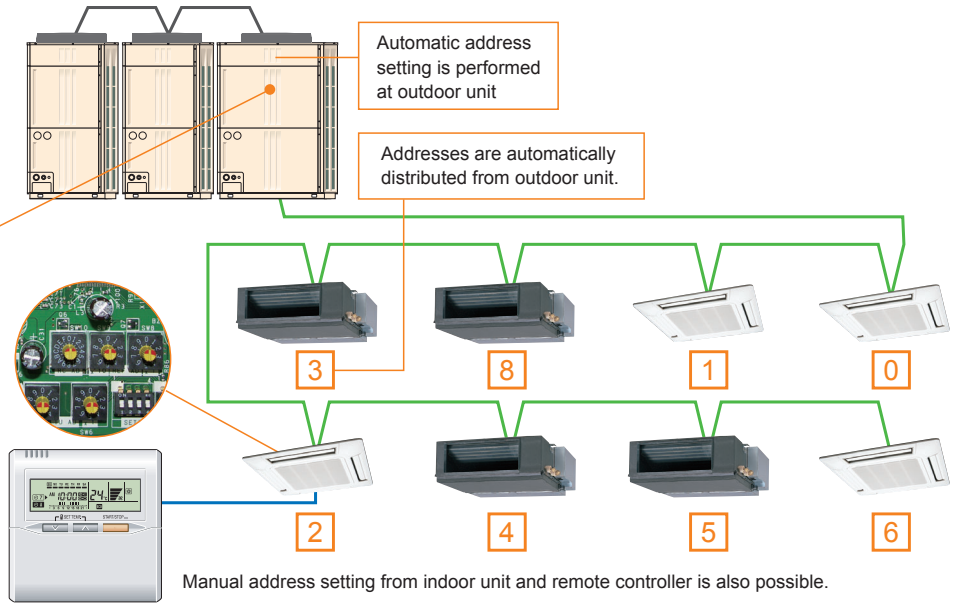
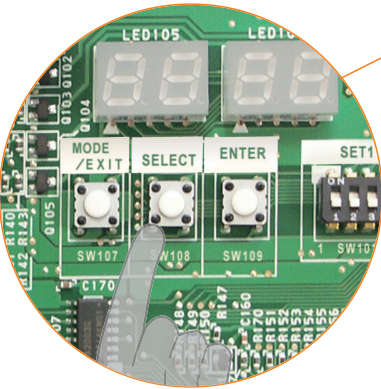

Easy maintenance

Easy access

By adopting a L-Shape front panel that can be removed, the work space for installation and service has been significantly expanded by this corner cutting structure. For multiple installations, work is performed easily and efficiently even in a narrow space.

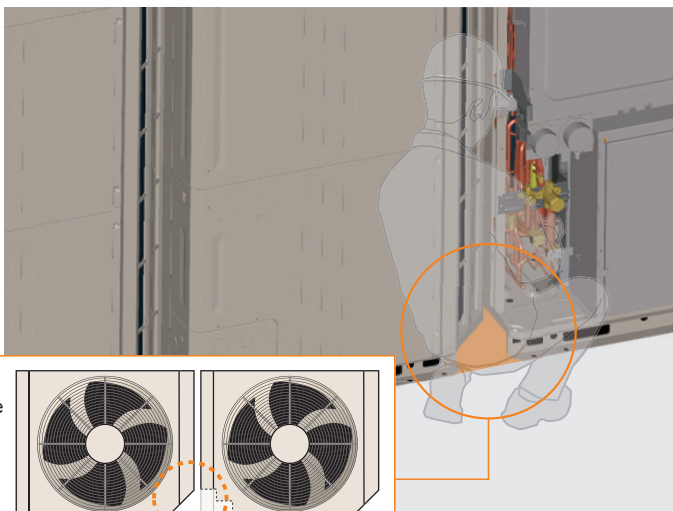

Four way piping connection

Piping and wiring are available to the front, left and right, and bottom.

Four way connection

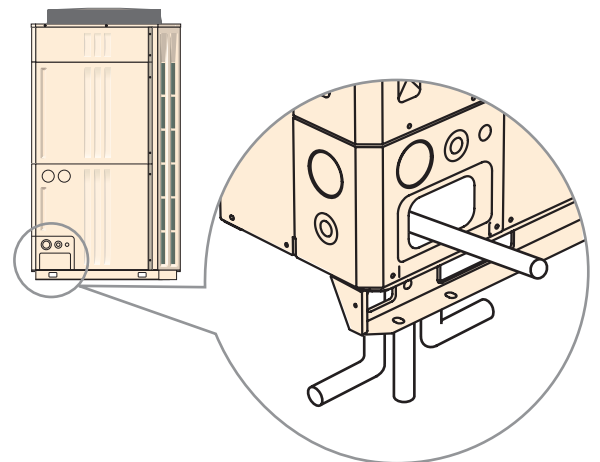

Comfort and Convenience

Low noise, easy operational settings, and comfortable temperature adjustment allows for V-II systems to be used in building air conditioning applications.

Quiet operation

Low noise mode

Two low noise modes can be selected automatically by quiet priority setting and capacity priority setting depending on the usage environment and outside temperature load.

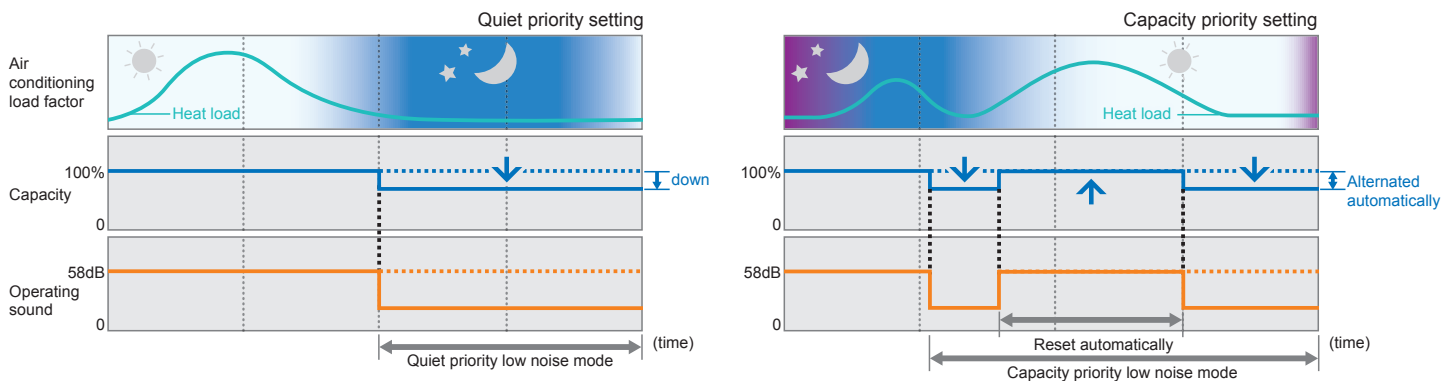

Low noise design

Compressor noise has been significantly reduced by shielding the compressor compartment.

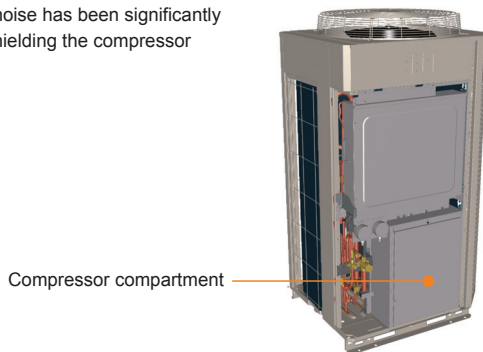

Indoor unit

Low noise indoor unit lineup



Auto changeover function

Selectable auto changeover function

Auto changeover setting allows for the product to easily switch between Cooling and heating modes regardless of the operation mode of other indoor units. This can be done via specific indoor unit remote controller and/or by an external input control. This ensures comfortable operation all year round.

Command for operational mode switching is controlled by one of the following options.

1 selected from the following:

- 1 Various remote controllers connected to indoor unit
- 2 External input terminal of outdoor unit
- 3 System controller

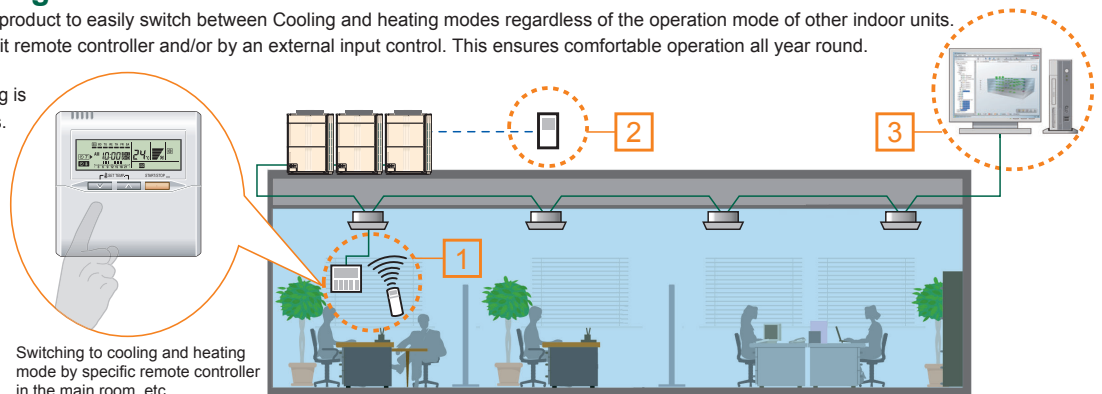



Comfortable, convenient control

■ Precision refrigerant flow control

Precision and Smooth refrigerant flow control is achieved by using a DC Inverter control in conjunction with individual indoor unit electronic expansion valve control. This allows for a high precision comfortable temperature control of $\pm 0.5^{\circ}\text{C}$.

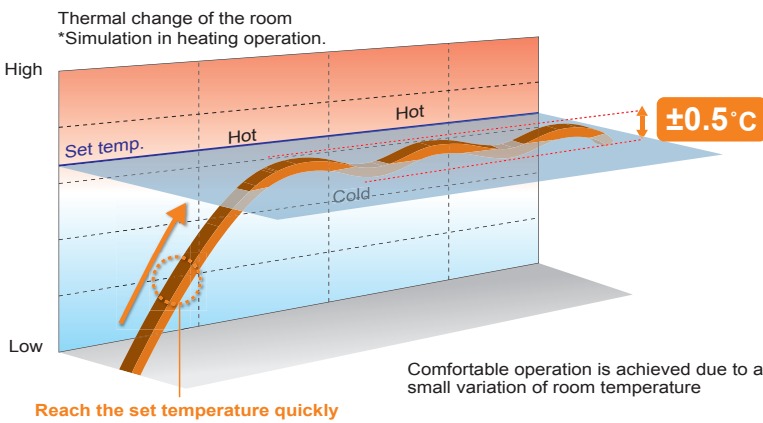

■ Individual Air Conditioning Control

The desired temperature conditions of each room are met due to the Individual thermostat control of each indoor unit.

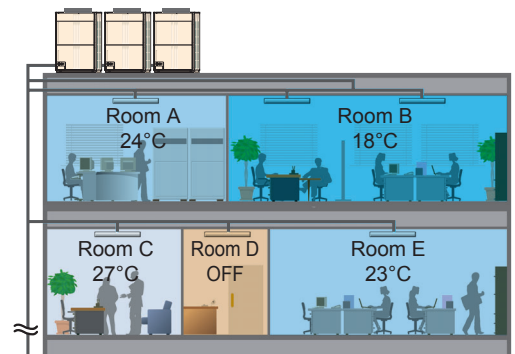

■ Simple central management function



7.5 inch large LCD Touch Panel Controller

- Simple central control operation Simple operation by icon display and color touch screen
- Yearly schedule function Daily starting & stopping and temperature setting are managed.
- Clock setting function The clock of each individual controller is periodically corrected.



Schedule screen

Non-stop oil recovery operation

A comfortable room condition is maintained during oil recovery mode because the product continues to operate without stopping the cooling or heating operation.

Previous model

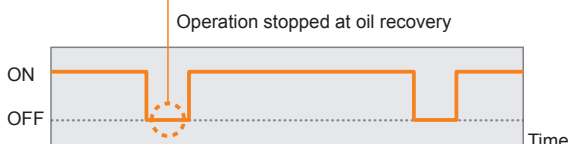

V-II Series

(Heating operation)



Easy Service & Maintenance

Designed for Quick Service response,
Easy maintenance and Troubleshooting

Design for easy service and maintenance

■ Inspection and replacement of main parts is easier due to innovative construction and an LED operational display.

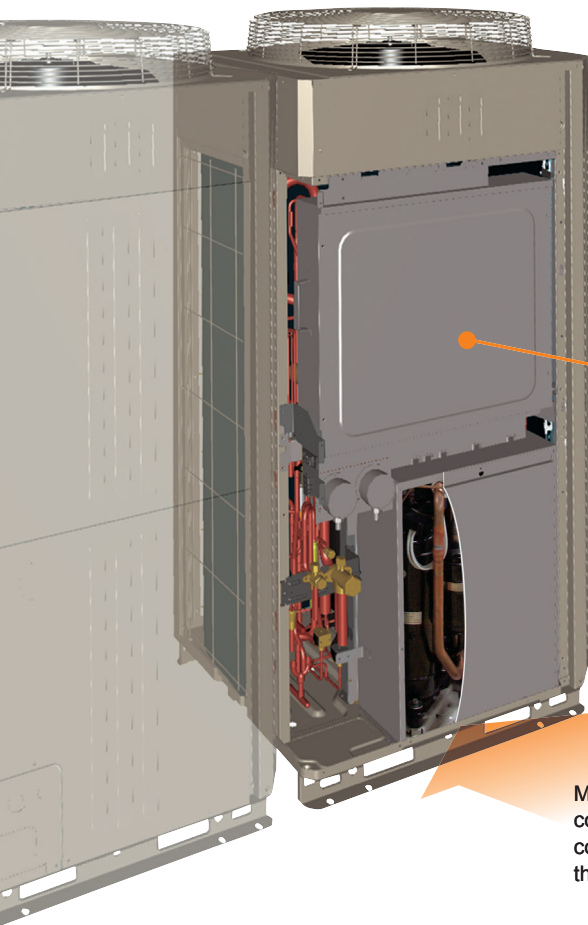

Consolidated electrical components make maintenance easy

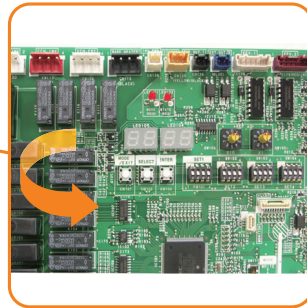

Movable PCB panel that allows for easier maintenance work behind the PCB

Maintenance of electrical components, valves, and compressor parts from the front is possible.

Easy-to-read 7-segment LED display which explains operational and trouble status

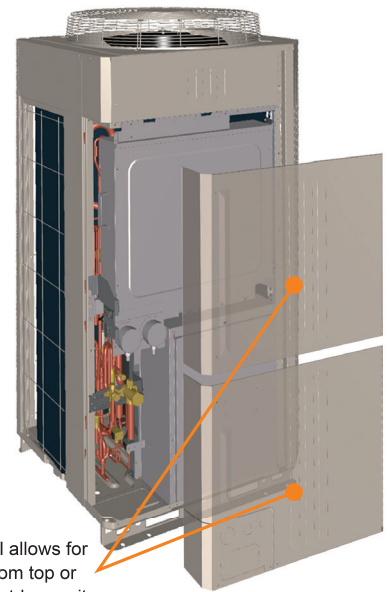
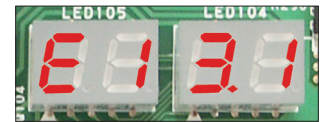

Split front panel allows for maintenance from top or bottom of the outdoor unit

■ Error status can be checked easily via the indoor unit wired controller

An error code is displayed on a liquid crystal screen.

Wired Remote Controller

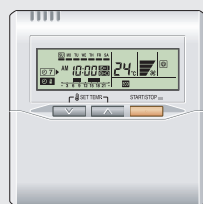

Faulty unit number (Remote controller address)

Error code

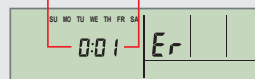

Simple Remote Controller



Faulty unit number (Remote controller address)

Error code

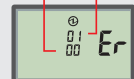



Emergency stop function

Emergency stop

Emergency alarm can be received by indoor, outdoor units or Touch Panel Controller when they received it, all units will be stopped.

Note:
In case of received Emergency alarm by Indoor/outdoor unit: All units connected within same refrigerant system will be stopped.
Touch Panel Controller: all unit connected within VRF network system with Touch Panel Controller will be stopped.

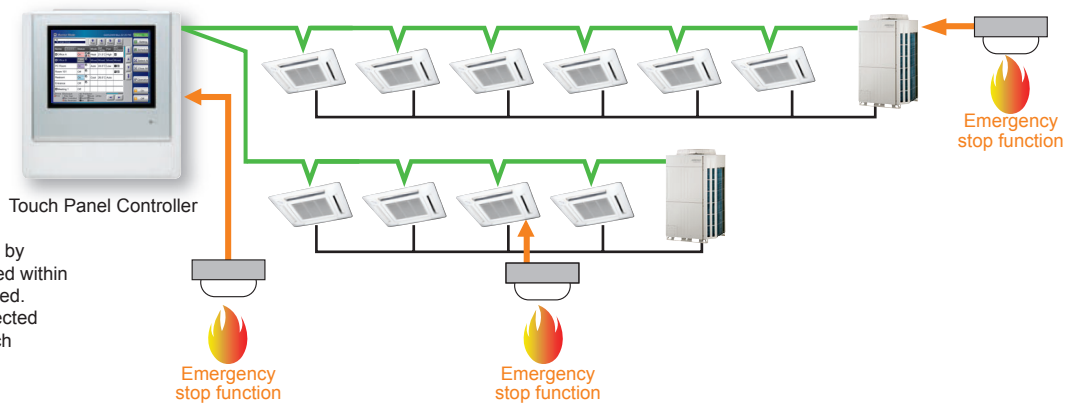

Continuous operation during maintenance

Non-stop operation

When servicing a specific indoor unit, maintenance can be performed even without turning off the other indoor units.

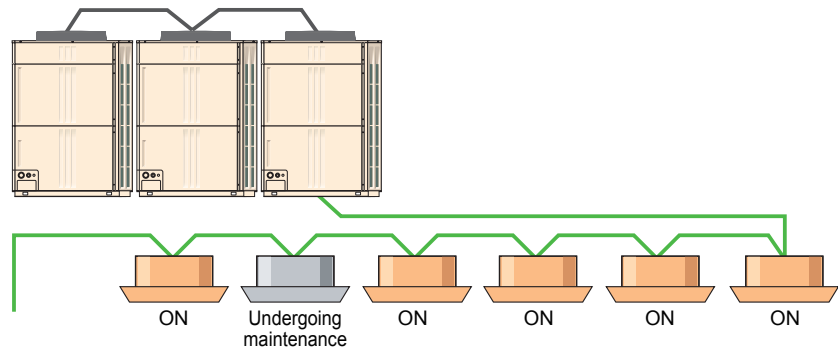

Prompt trouble diagnosis

Trouble diagnosis by Service Tool

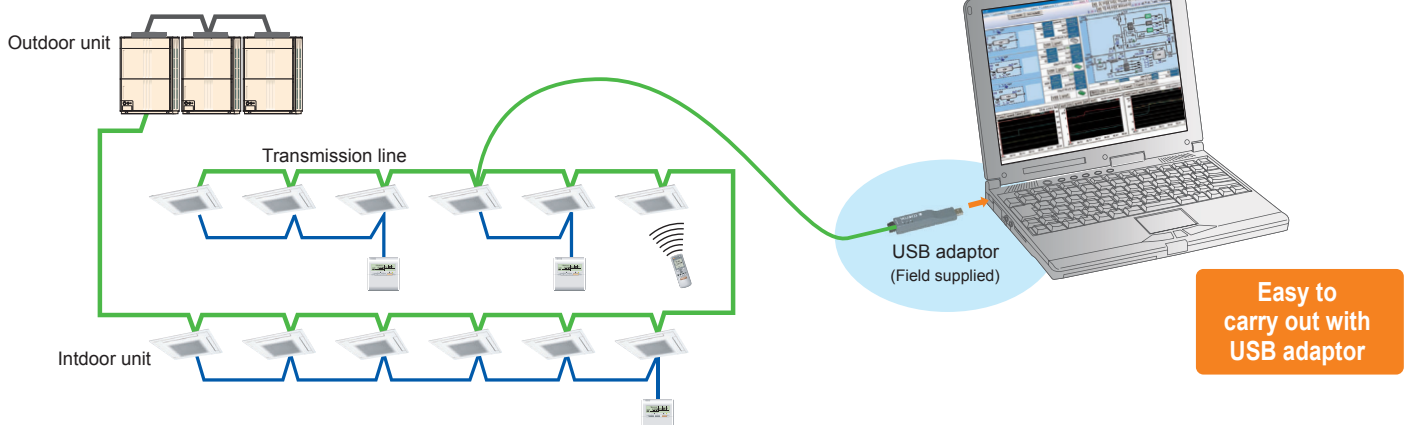

Suitable maintenance is possible by analysis of the operation data. Connection anywhere in the VRF network is easy.



Outdoor Units Lineup

- Extensive line up from 8HP to 48HP in 2HP increments
- Space saving combination and Energy efficiency combination available, which can be selected to suit any air conditioning needs
- Combinations other than the followings are not recommended.

■ Space saving combination

<p>22.4kW (8HP)</p>  <p>AJ*A72LALH UNIT : AJ*A72LALH</p>	<p>28.0kW (10HP)</p>  <p>AJ*A90LALH UNIT : AJ*A90LALH</p>	<p>33.5kW (12HP)</p>  <p>AJ*108LALH UNIT : AJ*108LALH</p>
<p>40.0kW (14HP)</p>  <p>AJ*126LALH UNIT : AJ*126LALH</p>	<p>45.0kW (16HP)</p>  <p>AJ*144LALH UNIT : AJ*144LALH</p>	<p>50.4kW (18HP)</p>  <p>AJ*162LALH UNIT : AJ*A90/A72LALH</p>
<p>55.9kW (20HP)</p>  <p>AJ*180LALH UNIT : AJ*108/A72LALH</p>	<p>61.5kW (22HP)</p>  <p>AJ*198LALH UNIT : AJ*108/A90LALH</p>	<p>67.0kW (24HP)</p>  <p>AJ*216LALH UNIT : AJ*108/108LALH</p>
<p>73.5kW (26HP)</p>  <p>AJ*234LALH UNIT : AJ*126/108LALH</p>	<p>78.5kW (28HP)</p>  <p>AJ*252LALH UNIT : AJ*144/108LALH</p>	<p>85.0kW (30HP)</p>  <p>AJ*270LALH UNIT : AJ*144/126LALH</p>
<p>90.0kW (32HP)</p>  <p>AJ*288LALH UNIT : AJ*144/144LALH</p>	<p>95.0kW (34HP)</p>  <p>AJ*306LALH UNIT : AJ*108/108/A90LALH</p>	<p>100.5kW (36HP)</p>  <p>AJ*324LALH UNIT : AJ*108/108/108LALH</p>
<p>107.0kW (38HP)</p>  <p>AJ*342LALH UNIT : AJ*126/108/108LALH</p>	<p>112.0kW (40HP)</p>  <p>AJ*360LALH UNIT : AJ*144/108/108LALH</p>	<p>118.5kW (42HP)</p>  <p>AJ*378LALH UNIT : AJ*144/126/108LALH</p>
<p>123.5kW (44HP)</p>  <p>AJ*396LALH UNIT : AJ*144/144/108LALH</p>	<p>130.0kW (46HP)</p>  <p>AJ*414LALH UNIT : AJ*144/144/126LALH</p>	<p>135.0kW (48HP)</p>  <p>AJ*432LALH UNIT : AJ*144/144/144LALH</p>

■ Energy efficiency combination

44.8kW (16HP)



AJ*144LALHH
UNIT : AJ*A72/A72LALH

62.4kW (22HP)



AJ*198LALHH
UNIT : AJ*126/A72LALH

67.2kW (24HP)



AJ*216LALHH
UNIT : AJ*A72/A72/A72LALH

72.8kW (26HP)



AJ*234LALHH
UNIT : AJ*A90/A72/A72LALH

78.3kW (28HP)



AJ*252LALHH
UNIT : AJ*108/A72/A72LALH

84.8kW (30HP)



AJ*270LALHH
UNIT : AJ*126/A72/A72LALH

89.8kW (32HP)



AJ*288LALHH
UNIT : AJ*108/108/A72LALH

95.9kW (34HP)



AJ*306LALHH
UNIT : AJ*126/108/A72LALH

102.4kW (36HP)



AJ*324LALHH
UNIT : AJ*126/126/A72LALH

113.5kW (40HP)



AJ*360LALHH
UNIT : AJ*126/126/A108LALH

120.0kW (42HP)



AJ*378LALHH
UNIT : AJ*126/126/126LALH

125.0kW (44HP)



AJ*396LALHH
UNIT : AJ*144/126/126LALH

Innovative Technology



1 Powerful large propeller fan



By using CFD*1 technology, A newly designed fan achieves high performance and low noise operation.

2 DC fan motor



High Performance and High Efficiency has been realized by using a small DC fan motor which has reduced power consumption by 25% when compared with the previous model.

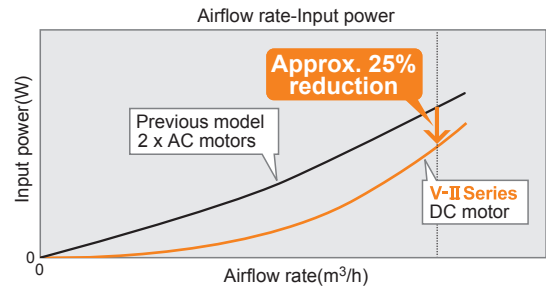

3 Subcool heat exchanger

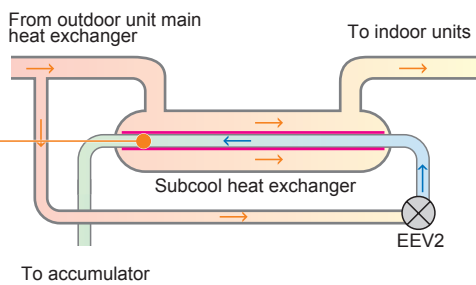
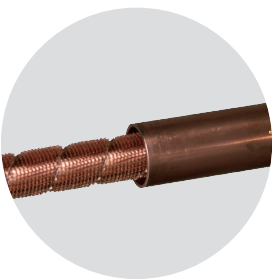

High Heat Exchange efficiency is achieved by using a internal projection shape double pipe construction.

4 Sine wave DC inverter control

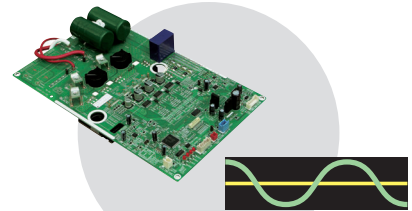

A DC Sine wave inverter control has been used which allows for a high efficiency and high energy saving operation. Inverter losses are significantly reduced by newly adopted IPM and original motor control.

5 DC twin rotary compressor

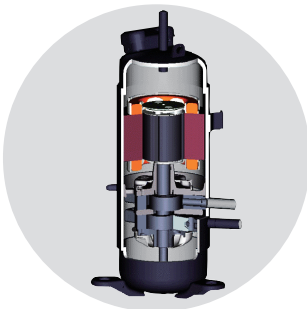

A high performance, low noise, large capacity DC twin rotary compressor is used. Each part is optimized with intake and compression efficiency increased to the maximum extent. In addition, high performance and high quality is maintained by using a double accumulator.

6 Round-corner type high density multi path heat exchanger

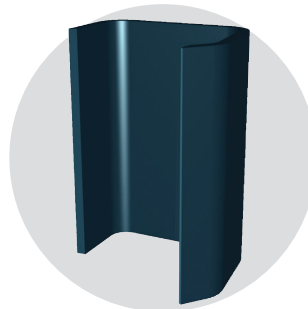

Reduced compact size and energy saving has been realised by utilizing a $\phi 7\text{mm}$ high density piping design with a unique enclosing shape. This new coil design allows for an increase of approximately 1.7 times heat exchanger volume when compared with the previous model.

7 Front intake port (corner cut air inhaling structure)

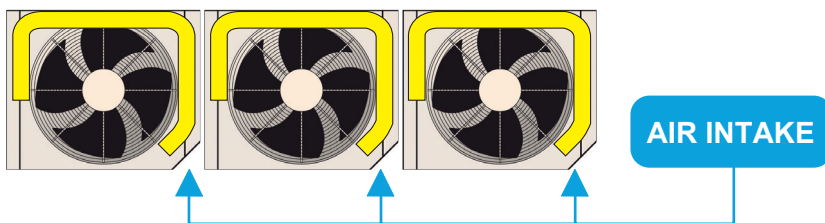



Front intake port is designed to prevent decreasing airflow when multiple outdoor units are installed.





*1: CFD = Computational Fluid Dynamics

Specifications

Space saving combination

Rating Capacity range		HP	8	10	12	14	16	18	20	22	24
											
Set Model			AJ*A72LALH	AJ*A90LALH	AJ*108LALH	AJ*126LALH	AJ*144LALH	AJ*162LALH	AJ*180LALH	AJ*198LALH	AJ*216LALH
Unit 1 Unit 2 Unit 3			AJ*A72LALH	AJ*A90LALH	AJ*108LALH	AJ*126LALH	AJ*144LALH	AJ*A90LALH AJ*A72LALH	AJ*108LALH AJ*A72LALH	AJ*108LALH AJ*A90LALH	AJ*108LALH AJ*108LALH
Maximum Connectable Indoor Unit*1			15	16	17	21	24	32	32	32	35
Indoor unit connectable capacity		Cooling kW	11.2-33.6	14.0-42.0	16.8-50.2	20.0-60.0	22.4-67.2	25.2-75.6	28.0-83.9	30.8-92.3	33.5-100.5
Power source											
Capacity	Cooling	kW	22.4	28.0	33.5	40.0	45.0	50.4	55.9	61.5	67.0
	Heating		25.0	31.5	37.5	45.0	50.0	56.5	62.5	69.0	75.0
Input power	Cooling	kW	5.51	7.73	9.62	11.53	14.17	13.24	15.13	17.35	19.24
	Heating		5.72	7.83	9.28	11.45	12.60	13.55	15.00	17.11	18.56
EER	Cooling	W/W	4.07	3.62	3.48	3.47	3.18	3.81	3.69	3.54	3.48
COP	Heating		4.37	4.02	4.04	3.93	3.97	4.17	4.17	4.03	4.04
Airflow rate	High	m ³ /h	11,100	11,100	11,100	13,000	13,000	11,100 x 2	11,100 x 2	11,100 x 2	11,100 x 2
Sound pressure level*2	Cooling	dB (A)	56	58	58	60	61	60	60	61	61
	Heating		58	59	60	61	61	62	62	63	63
Maximum external static pressure		Pa	80	80	80	80	80	80	80	80	80
Compressor motor output		kW	3.9	3.9	3.9 + 4.5	3.9 + 4.5	3.9 + 4.5	3.9 x 2	3.9 x 2 + 4.5	3.9 x 2 + 4.5	3.9 x 2 + 4.5 x 2
Heat exchanger fin			Blue fin	Blue fin	Blue fin	Blue fin	Blue fin	Blue fin	Blue fin	Blue fin	Blue fin
Dimensions	Height	mm	1,690	1,690	1,690	1,690	1,690	1,690	1,690	1,690	1,690
	Width	mm	930	930	930	1,240	1,240	930 x 2	930 x 2	930 x 2	930 x 2
	Depth	mm	765	765	765	765	765	765	765	765	765
Weight		kg	220	220	275	296	296	220+220	275+220	275+220	275+275
Refrigerant charge		kg	11.2	11.2	11.8	11.8	11.8	11.2 x 2	11.8 + 11.2	11.8 + 11.2	11.8 x 2
Connection pipe diameter	Liquid	mm	12.70	12.70	12.70	12.70	12.70	15.88	15.88	15.88	15.88
	Gas		22.20	22.20	28.58	28.58	28.58	28.58	28.58	34.92	34.92
Operation temperature range	Cooling	°C	-15 to 46	-15 to 46	-15 to 46	-15 to 46	-15 to 46	-5 to 46	-5 to 46	-5 to 46	-5 to 46
	Heating		-20 to 21	-20 to 21	-20 to 21	-20 to 21	-20 to 21	-20 to 21	-20 to 21	-20 to 21	-20 to 21

Energy efficiency combination

Rating Capacity range		HP	16	22	24	26	28	30
								
Set Model			AJ*144LALHH	AJ*198LALHH	AJ*216LALHH	AJ*234LALHH	AJ*252LALHH	AJ*270LALHH
Unit 1 Unit 2 Unit 3			AJ*A72LALH AJ*A72LALH	AJ*126LALH AJ*A72LALH	AJ*A72LALH AJ*A72LALH AJ*A72LALH	AJ*A90LALH AJ*A72LALH AJ*A72LALH	AJ*108LALH AJ*A72LALH AJ*A72LALH	AJ*126LALH AJ*A72LALH AJ*A72LALH
Maximum Connectable Indoor Unit*1			30	33	36	39	42	45
Indoor unit connectable capacity		Cooling kW	22.4-67.2	31.2-93.6	33.6-100.8	36.4-109.2	39.2-117.4	42.4-127.2
Power source								
Capacity	Cooling	kW	44.8	62.4	67.2	72.8	78.3	84.8
	Heating		50.0	70.0	75.0	81.5	87.5	95.0
Input power	Cooling	kW	11.02	17.04	16.53	18.75	20.64	22.55
	Heating		11.44	17.17	17.16	19.27	20.72	22.89
EER	Cooling	W/W	4.07	3.66	4.07	3.88	3.79	3.76
COP	Heating		4.37	4.08	4.37	4.23	4.22	4.15
Airflow rate	High	m ³ /h	11,100 x 2	13,000 + 11,100	11,100 x 3	11,100 x 3	11,100 x 3	13,000+11,000 x 2
Sound pressure level*2	Cooling	dB (A)	59	61	61	62	62	63
	Heating		59	62	61	62	63	63
Maximum external static pressure		Pa	80	80	80	80	80	80
Compressor motor output		kW	3.9 x 2	3.9 x 2+4.5	3.9 x 3	3.9 x 3	3.9 x 3+4.5	3.9 x 3+4.5
Heat exchanger fin			Blue fin	Blue fin	Blue fin	Blue fin	Blue fin	Blue fin
Dimensions	Height	mm	1,690	1,690	1,690	1,690	1,690	1,690
	Width	mm	930 x 2	930+1,240	930 x 3	930 x 3	930 x 3	930 x 2+1,240
	Depth	mm	765	765	765	765	765	765
Weight		kg	220+220	296+220	220+220+220	220+220+220	275+220+220	296+220+220
Refrigerant charge		kg	11.2 x 2	11.8 + 11.2	11.2 x 3	11.2 x 3	11.8 + 11.2 x 2	11.8 + 11.2 x 2
Connection pipe diameter	Liquid	mm	12.70	15.88	15.88	15.88	15.88	19.05
	Gas		28.58	34.92	34.92	34.92	34.92	34.92
Operation temperature range	Cooling	°C	-5 to 46	-5 to 46	-5 to 46	-5 to 46	-5 to 46	-5 to 46
	Heating		-20 to 21	-20 to 21	-20 to 21	-20 to 21	-20 to 21	-20 to 21

AJ* : AJY(FUJITSU), AJH(GENERAL)

Note : Specifications are based on the following conditions.
 Cooling : Indoor temperature of 27°CDB / 19°CWB, and outdoor temperature of 35°CDB / 24°CWB.
 Heating : Indoor temperature of 20°CDB / (15°CWB), and outdoor temperature of 7°CDB / 6°CWB.
 Pipe length : 7.5 m; Height difference between outdoor unit and indoor unit : 0 m.
 When cooling operation will be conducted at outdoor air temperature below -5°C,
 the outdoor unit must be installed in a position that is higher than or equal to those of indoor units.

*1 Minimum connectable indoor unit number is 2.
 However ARXC72 and ARXC90 can be used signal connection.
 *2 The noise value is the value when measured in an anechoic room.
 When measured in the actual installed state, surrounding noise and reflections are received and the measured value is usually larger than the indicated value.

26	28	30	32	34	36	38	40	42	44	46	48
AJ*234LALH AJ*126LALH AJ*108LALH	AJ*252LALH AJ*144LALH AJ*108LALH	AJ*270LALH AJ*144LALH AJ*126LALH	AJ*288LALH AJ*144LALH AJ*144LALH	AJ*306LALH AJ*108LALH AJ*108LALH AJ*A90LALH	AJ*324LALH AJ*108LALH AJ*108LALH AJ*108LALH	AJ*342LALH AJ*126LALH AJ*108LALH AJ*108LALH	AJ*360LALH AJ*144LALH AJ*108LALH AJ*108LALH	AJ*378LALH AJ*144LALH AJ*126LALH AJ*108LALH	AJ*396LALH AJ*144LALH AJ*144LALH AJ*108LALH	AJ*414LALH AJ*144LALH AJ*144LALH AJ*126LALH	AJ*432LALH AJ*144LALH AJ*144LALH AJ*144LALH
39	42	45	48	48	48	48	48	48	48	48	48
36.8-110.3	39.3-117.8	42.5-127.5	45.0-135.0	47.5-142.5	50.3-150.8	53.5-160.5	56.0-168.0	59.3-177.8	61.8-185.3	65.0-195.0	67.5-202.5

3-phase 4 wire, 400 V, 50Hz											
73.5	78.5	85.0	90.0	95.0	100.5	107.0	112.0	118.5	123.5	130.0	135.0
82.5	87.5	95.0	100.0	106.5	112.5	120.0	125.0	132.5	137.5	145.0	150.0
21.15	23.79	25.70	28.34	26.97	28.86	30.77	33.41	35.32	37.96	39.87	42.51
20.73	21.88	24.05	25.20	26.39	27.84	30.01	31.16	33.33	34.48	36.65	37.80
3.48	3.30	3.31	3.18	3.52	3.48	3.48	3.35	3.36	3.25	3.26	3.18
3.98	4.00	3.95	3.97	4.04	4.04	4.00	4.01	3.98	3.99	3.96	3.97
13,000+11,100	13,000+11,100	13,000 x 2	13,000 x 2	11,100 x 3	11,100 x 3	13,000+11,100x2	13,000+11,100x2	13,000x2+11,100	13,000x2+11,100	13,000 x 3	13,000 x 3
62	63	64	64	63	63	64	64	65	65	65	66
64	64	64	64	64	65	65	65	65	65	66	66
80	80	80	80	80	80	80	80	80	80	80	80
3.9 x 2 + 4.5 x 2	3.9 x 2 + 4.5 x 2	3.9 x 2 + 4.5 x 2	3.9 x 2 + 4.5 x 2	3.9 x 3 + 4.5 x 2	3.9 x 3 + 4.5 x 3	3.9 x 3 + 4.5 x 3	3.9 x 3 + 4.5 x 3	3.9 x 3 + 4.5 x 3	3.9 x 3 + 4.5 x 3	3.9 x 3 + 4.5 x 3	3.9 x 3 + 4.5 x 3
Blue fin	Blue fin	Blue fin	Blue fin	Blue fin	Blue fin	Blue fin	Blue fin	Blue fin	Blue fin	Blue fin	Blue fin
1,690	1,690	1,690	1,690	1,690	1,690	1,690	1,690	1,690	1,690	1,690	1,690
930+1,240	930+1,240	1,240 x 2	1,240 x 2	930 x 3	930 x 3	930 x 2 + 1,240	930 x 2 + 1,240	930 + 1,240 x 2	930 + 1,240 x 2	1,240 x 3	1,240 x 3
765	765	765	765	765	765	765	765	765	765	765	765
296+275	296+275	296+296	296+296	275+275+220	275+275+275	296+275+275	296+275+275	296+296+275	296+296+275	296+296+296	296+296+296
11.8 x 2	11.8 x 2	11.8 x 2	11.8 x 2	11.8 x 2 + 11.2	11.8 x 3	11.8 x 3	11.8 x 3	11.8 x 3	11.8 x 3	11.8 x 3	11.8 x 3
15.88	15.88	19.05	19.05	19.05	19.05	19.05	19.05	19.05	19.05	19.05	19.05
34.92	34.92	34.92	34.92	34.92	41.27	41.27	41.27	41.27	41.27	41.27	41.27
-5 to 46	-5 to 46	-5 to 46	-5 to 46	-5 to 46	-5 to 46	-5 to 46	-5 to 46	-5 to 46	-5 to 46	-5 to 46	-5 to 46
-20 to 21	-20 to 21	-20 to 21	-20 to 21	-20 to 21	-20 to 21	-20 to 21	-20 to 21	-20 to 21	-20 to 21	-20 to 21	-20 to 21

32	34	36	40	42	44
AJ*108LALH AJ*108LALH AJ*A72LALH	AJ*126LALH AJ*108LALH AJ*A72LALH	AJ*126LALH AJ*126LALH AJ*A72LALH	AJ*126LALH AJ*126LALH AJ*A108LALH	AJ*126LALH AJ*126LALH AJ*126LALH	AJ*144LALH AJ*126LALH AJ*126LALH
48	48	48	48	48	48
44.7-134.1	48.0-143.8	51.2-153.6	56.8-170.2	60.0-180.0	62.5-187.5

3-phase 4 wire, 400 V, 50Hz					
89.4	95.9	102.4	113.5	120.0	125.0
100.0	107.5	115.0	127.5	135.0	140.0
24.75	26.66	28.57	32.68	34.59	37.23
24.28	26.45	28.62	32.18	34.35	35.50
3.61	3.60	3.58	3.47	3.47	3.36
4.12	4.06	4.02	3.96	3.93	3.94
11,100 x 3	13,000+11,100 x 2	13,000 x 2+11,100	13,000 x 2+11,100	13,000 x 3	13,000 x 3
62	63	64	64	65	65
64	64	65	65	66	66
80	80	80	80	80	80
3.9 x 3+4.5 x 2	3.9 x 3+4.5 x 2	3.9 x 3+4.5 x 2	3.9 x 3+4.5 x 3	3.9 x 3+4.5 x 3	3.9 x 3+4.5 x 3
Blue fin	Blue fin	Blue fin	Blue fin	Blue fin	Blue fin
1,690	1,690	1,690	1,690	1,690	1,690
930 x 3	930 x 2+1,240	930+1,240 x 2	930+1,240 x 2	1,240 x 3	1,240 x 3
765	765	765	765	765	765
275+275+220	296+275+220	296+296+220	296+296+275	296+296+296	296+296+296
11.8 x 2+11.2	11.8 x 2+11.2	11.8 x 2+11.2	11.8 x 3	11.8 x 3	11.8 x 3
19.05	19.05	19.05	19.05	19.05	19.05
34.92	34.92	41.27	41.27	41.27	41.27
-5 to 46	-5 to 46	-5 to 46	-5 to 46	-5 to 46	-5 to 46
-20 to 21	-20 to 21	-20 to 21	-20 to 21	-20 to 21	-20 to 21

Dimensions

8, 10, 12HP

AJ*A72LALH
AJ*A90LALH
AJ*108LALH

(Unit : mm)

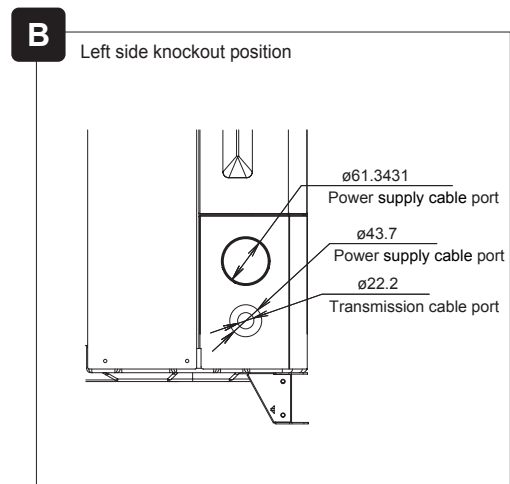
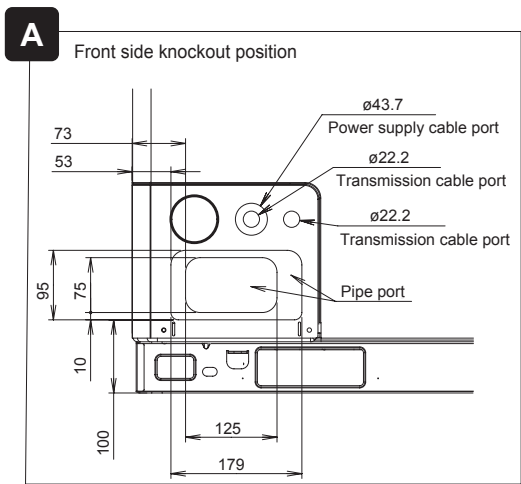
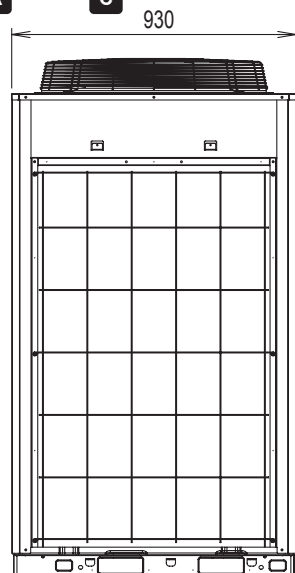
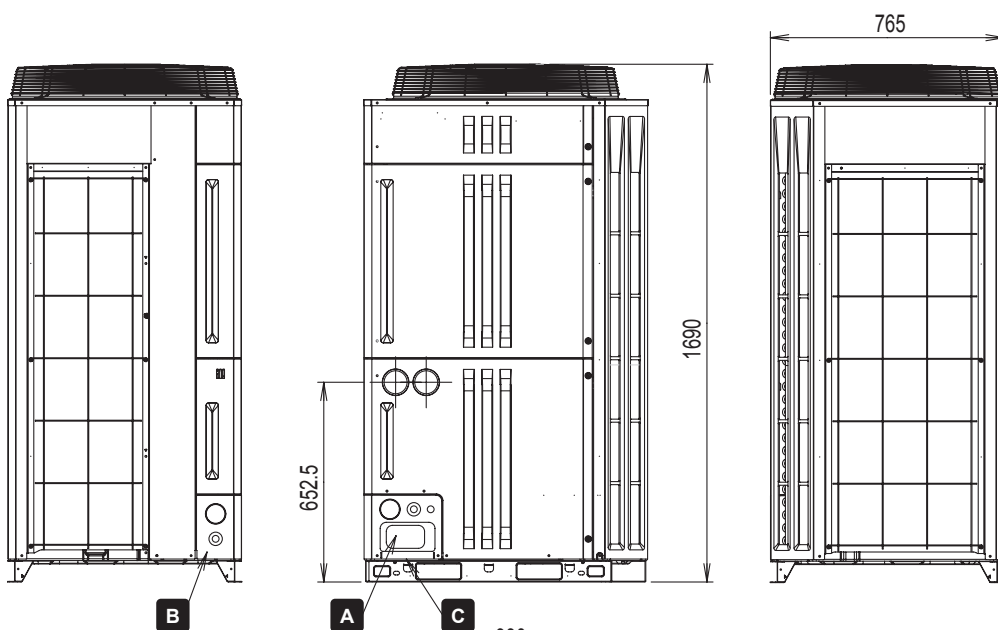
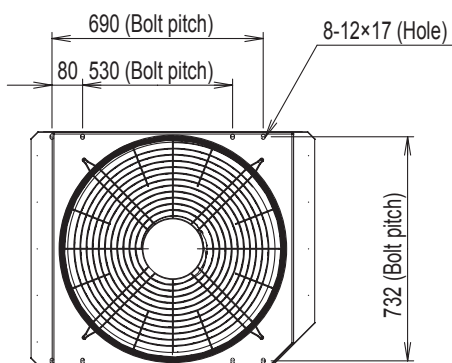



14, 16HP

AJ*126LALH
AJ*144LALH



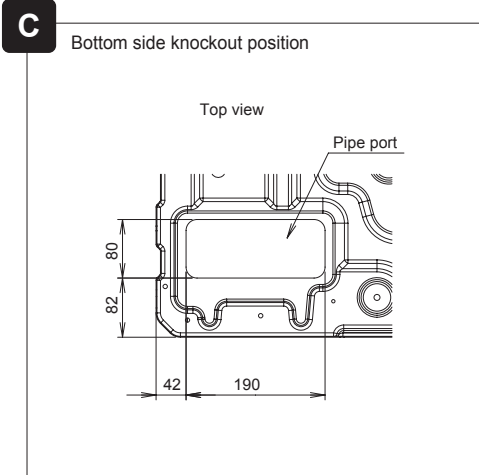
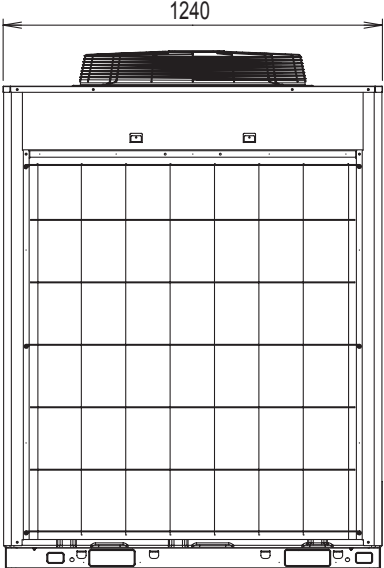
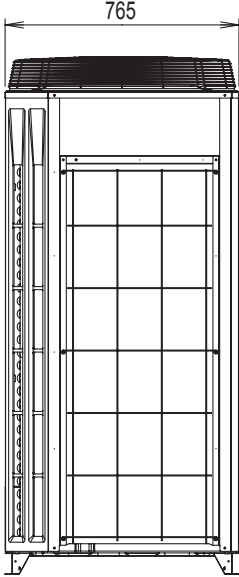
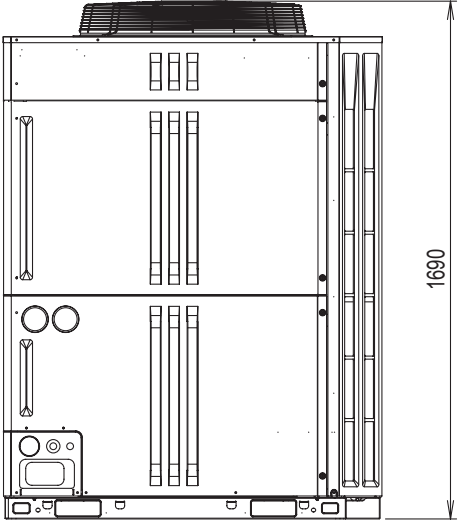
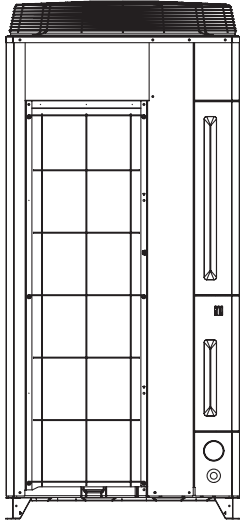
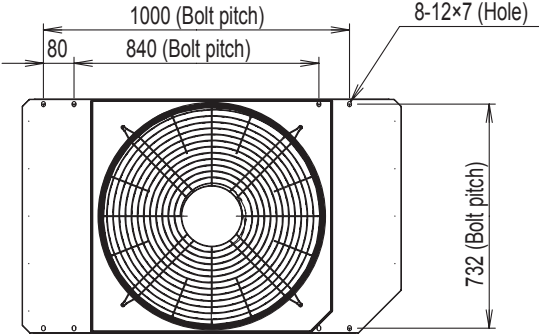

























(Unit : mm)



Indoor Unit Lineup







11 Types, 49 Models, Capacity range from 2.2kW to 25.0kW

Comprehensive range of indoor units of variety design and capacity ranges available which can be selected to suit any air conditioning needs.

Rating Capacity Range (kW)	2.2	2.8	3.6	4.5	5.6	7.1
Model code	7	9	12	14	18	24
Compact Cassette P26	 AUXB07LALH	 AUXB09LALH	 AUXB12LALH	 AUXB14LALH	 AUXB18LALH	 AUXB24LALH
Cassette P28					 AUXD18LALH	 AUXD24LALH
Compact Duct P30	 ARXB07LALH	 ARXB09LALH	 ARXB12LALH	 ARXB14LALH	 ARXB18LALH	
Low Static Pressure Duct P32						 ARXB24LATH
Duct P32						 ARXA24LATH
High Static Pressure Duct P34						
Floor / Ceiling P36			 AB*A12LATH	 AB*A14LATH	 AB*A18LATH	 AB*A24LATH
Ceiling P38						
Compact Wall Mounted (EEV internal) P40	 AS*A07LACH	 AS*A09LACH	 AS*A12LACH	 AS*A14LACH		
Compact Wall Mounted (EEV external) P40	 AS*E07LACH	 AS*E09LACH	 AS*E12LACH	 AS*E14LACH		
	With this model connection of EV kit is necessary.					
Wall Mounted P42					 AS*A18LATH	 AS*A24LATH

The indoor units above cannot be connected to the S or V Series.

AB* : ABY(FUJITSU), ABH(GENERAL) AS* : ASY(FUJITSU), ASH(GENERAL)

9.0	11.2	12.5	14.0	18.0	22.4	25.0
30	36	45	54	60	72	90
 AUXA30LALH	 AUXA36LALH	 AUXA45LALH	 AUXA54LALH			
 ARXB30LATH	 ARXB36LATH	 ARXB45LATH				
 ARXA30LATH	 ARXA36LATH	 ARXA45LATH				
	 ARXC36LATH	 ARXC45LATH		 ARXC60LATH	 ARXC72LATH	 ARXC90LATH
 AB*A30LATH	 AB*A36LATH	 AB*A45LATH	 AB*A54LATH			
 AS*A30LATH						

Compact Cassette

Compact size panel design
that fits standard ceiling panel (600x600mm)

Models

- AUXB07LALH
- AUXB09LALH
- AUXB12LALH
- AUXB14LALH
- AUXB18LALH
- AUXB24LALH



2-stage turbo fan

High efficiency design by 2 stage structure

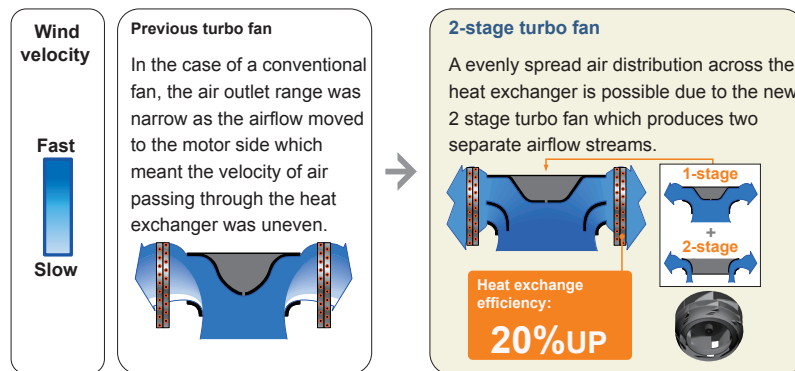

Quiet quality

Optimization of wing form (laminar wing type) and wing number (7 blades each)

Designed by CFD-analysis (fluid) simulations

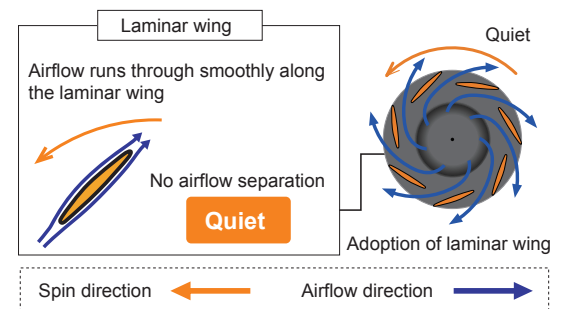

Specifications

Model name			AUXB07LALH	AUXB09LALH	AUXB12LALH	AUXB14LALH	AUXB18LALH	AUXB24LALH	
Power source			230V~, 50Hz						
Capacity	Cooling	kW	2.2	2.8	3.6	4.5	5.6	7.1	
	Heating		2.8	3.2	4.1	5.0	6.3	8.0	
Input power		W	25	25	29	35	36	84	
Airflow rate	High	m ³ /h	540	550	600	680	710	1,030	
	Med		450	450	530	590	580	830	
	Low		350	350	390	390	400	450	
Sound pressure level	High	dB(A)	34	35	37	38	41	50	
	Med		30	30	34	34	35	44	
	Low		25	25	27	27	27	30	
Dimensions (H x W x D)		mm	245 x 570 x 570						
Weight		kg	15				17		
Connection pipe diameter	Liquid (Flare)	mm	ø6.35				ø9.52		
	Gas (Flare)		ø12.70				ø15.88		
	Drain		ø25 (I.D.); ø32 (O.D.)						
Grille(option)	Model name		UTG-UF*C-W						
	Dimensions (H x W x D)	mm	50 x 700 x 700						
	Weight	kg	2.6						

F* : FY (FUJITSU) ; FG(GENERAL)

Note : Specifications are based on the following conditions.

Cooling : Indoor temperature of 27°CDB / 19°CWB, and outdoor temperature of 35°CDB / 24°CWB.

Heating : Indoor temperature of 20°CDB / (15°CWB), and outdoor temperature of 7°CDB / 6°CWB.

Pipe length : 7.5 m; Height difference between outdoor unit and indoor unit : 0 m.

Voltage : 230 [V].

Easy maintenance

① Maintenance of fan motor and fan

Maintenance of the fan motor and fan can be done easily after taking off the panel as the bell mouth of the fan can be removed easily.

A : Fan motor B : 2-stage turbo fan
C : Bell-mouth D : Panel

② Long life filter

: standard equipment

③ Adaptation of transparent drainage parts

During installation, maintenance and operation, the drain pump and kit can be checked easily.

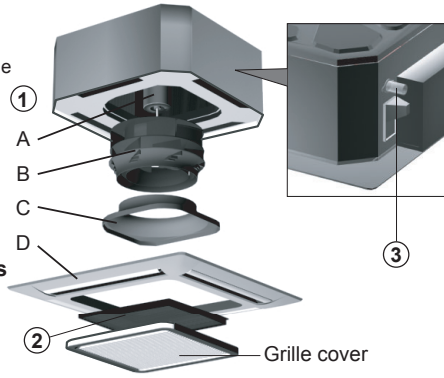

High ceiling mode

The compact cassette can be installed up to a height of 3.0m (12/14/18/24).

Model code	The maximum height from floor to ceiling (m)	
	Standard mode	High ceiling mode
07	2.7	-
09	2.7	-
12	2.7	3.0
14	2.7	3.0
18	2.7	3.0
24	2.7	3.0

Compact design

World's first 24,000Btu model in the compact cassette category

(Easy installation by taking off ceiling panel of 600 x 600 size)

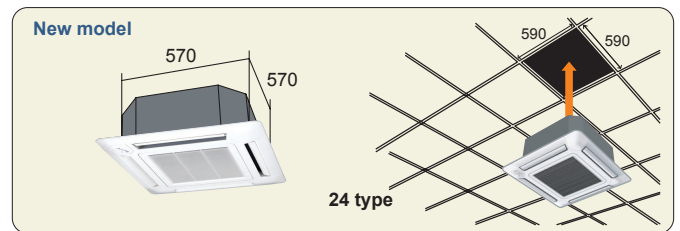
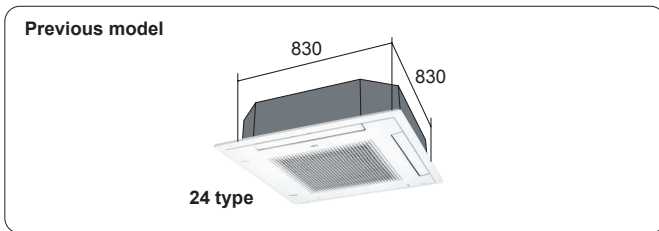

High lift drain pump

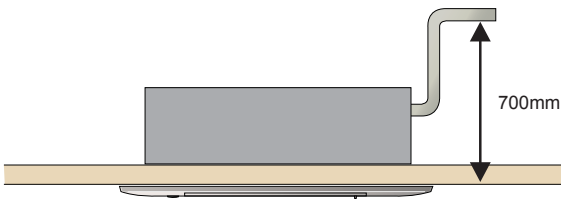

Optional parts

Air Outlet Shutter Plate

UTR-YDZB

Insulation Kit for High Humidity

UTZ-KXGC

Dimensions

Models: AUXB07 / AUXB09 / AUXB12 / AUXB14 / AUXB18 / AUXB24

(Unit : mm)

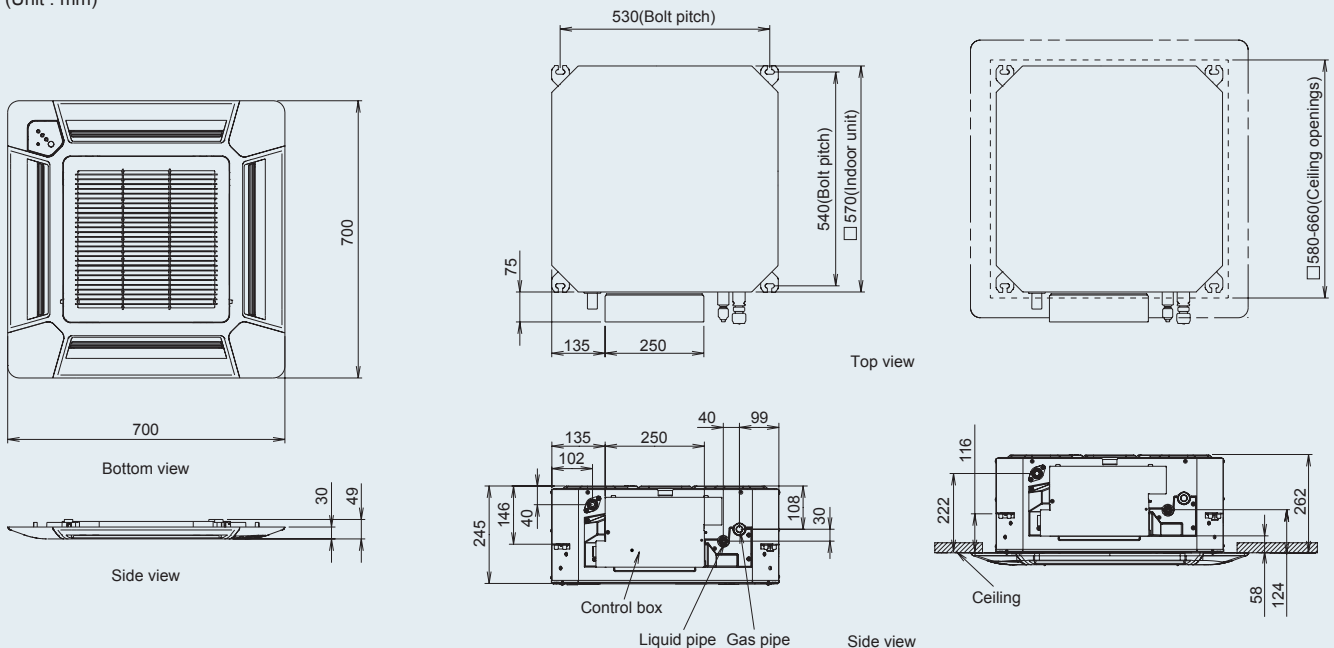

Cassette

Powerful, wide airflow and quiet operation

Models

- AUXD18LALH
- AUXD24LALH
- AUXA30LALH
- AUXA36LALH
- AUXA45LALH
- AUXA54LALH



High efficiency turbo fan with 3-dimensional blade

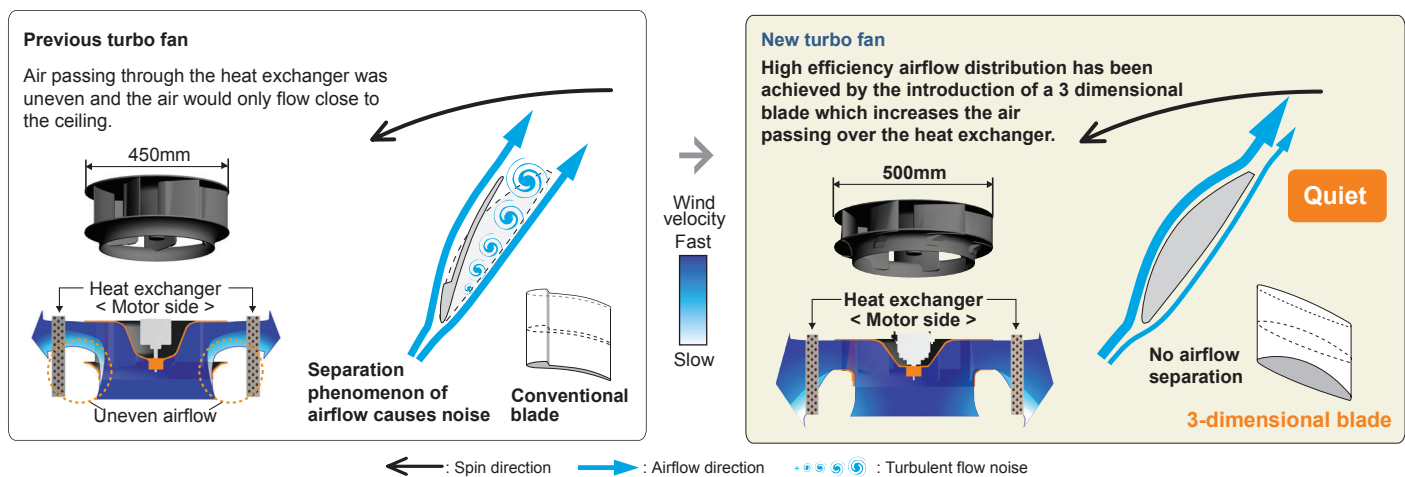

Specifications

Model name			AUXD18LALH	AUXD24LALH	AUXA30LALH	AUXA36LALH	AUXA45LALH	AUXA54LALH
Power source			230V~50Hz					
Capacity	Cooling	kW	5.6	7.1	9.0	11.2	12.5	14.0
	Heating		6.3	8.0	10.0	12.5	14.0	16.0
Input power		W	39	46	59	80	99	119
Airflow rate	High	m³/h	1,150	1,280	1,600	1,800	1,900	2,000
	Med		940	1,040	1,300	1,300	1,370	1,370
	Low		870	870	1,000	1,000	1,000	1,000
Sound pressure level	High	dB(A)	36	38	40	44	46	47
	Med		30	33	38	38	39	39
	Low		29	29	31	31	31	31
Dimensions (H x W x D)		mm	246 x 840 x 840			288 x 840 x 840		
Weight		kg	23			27		
Connection pipe diameter	Liquid (Flare)	mm	ø9.52					
	Gas (Flare)		ø15.88			ø19.05		
	Drain		ø25 (I.D.) ; ø32 (O.D.)					
Grille (option)	Model name		UTC-UG*A-W					
	Dimensions (H x W x D)		50 x 950 x 950					
	Weight		5.5					

G★ : GY(FUJITSU) ; GG(GENERAL)

Note : Specifications are based on the following conditions.

Cooling : Indoor temperature of 27°CDB / 19°CWB, and outdoor temperature of 35°CDB / 24°CWB.

Heating : Indoor temperature of 20°CDB / (15°CWB), and outdoor temperature of 7°CDB / 6°CWB.

Pipe length : 7.5 m; Height difference between outdoor unit and indoor unit : 0 m.

Voltage : 230 [V].

Improvement of the airflow distribution

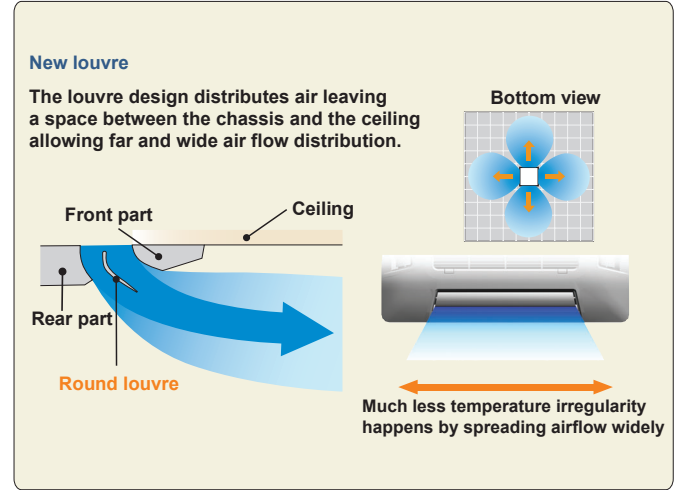
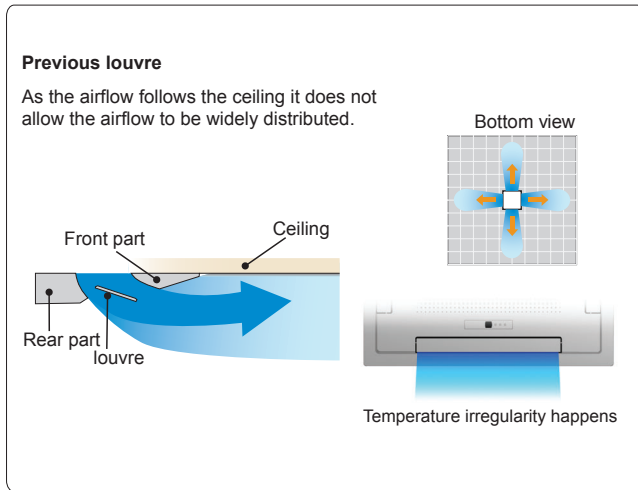

Adjustment of hanger position is possible after installation

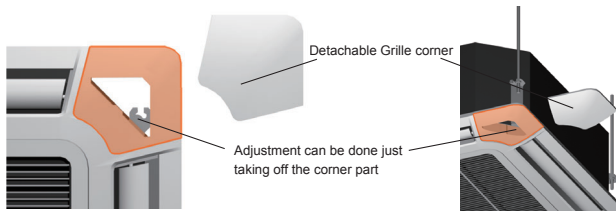

High ceiling mode

This cassette can be installed up to a height of 4.2m (36/45/54).

Model code	The maximum height from floor to ceiling (m)	
	Standard mode	High ceiling mode
18	3.0	3.5
24	3.0	3.5
30	3.2	3.6
36	3.2	4.2
45	3.2	4.2
54	3.2	4.2

High lift drain pump

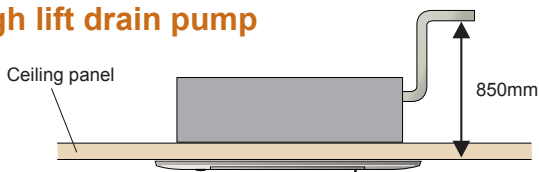

Optional Parts

- IR Receiver Kit UTY-LRH*B1
 - Air Outlet Shutter Plate UTR-YDZC
 - Panel Spacer UTG-BGYA-W
 - Insulation Kit for High Humidity UTZ-KXGA/UTZ-KXGB
 - Wide Panel UTG-AGYA-W
- H*: HY(FUJITSU); HG(GENERAL)

Dimensions

Models: AUXD18LALH / AUXD24LALH (Slim type)
 AUXA30LALH / AUXA36LALH / AUXA45LALH / AUXA54LALH
 (Unit : mm)
 () : AUXD18 / AUXD24

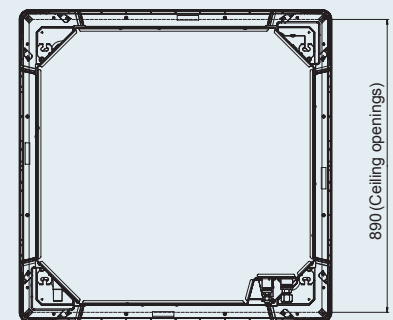
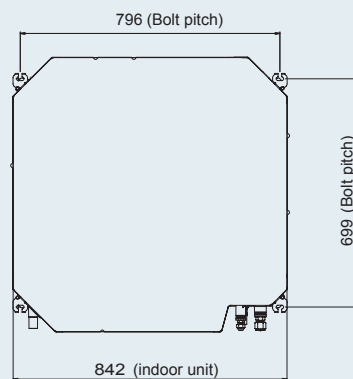
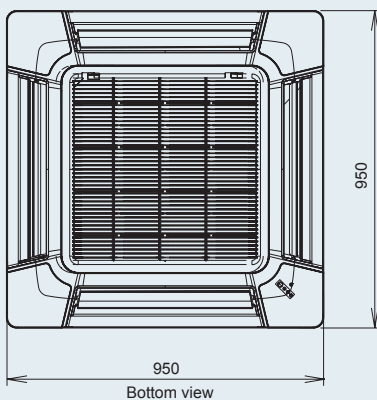

Top view

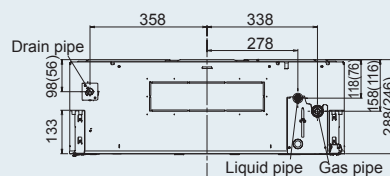

Side view

Compact Duct

Small and compact indoor unit suitable for many applications

Models

ARXB07LALH
ARXB09LALH



Models

ARXB12LALH
ARXB14LALH
ARXB18LALH



Low noise level

A low noise level has been achieved for each capacity

Model		7	9	12	14	18
Static pressure range	Pa	0 to 50				
Noise level (Low speed)	dB(A)	24	27	25	30	30

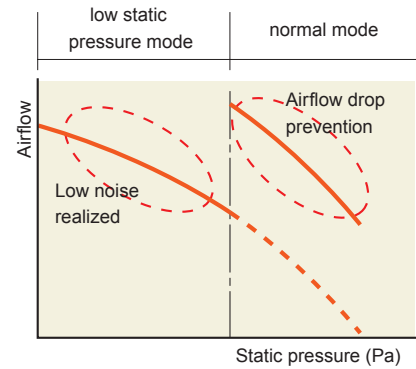

Specifications

Model name			ARXB07LALH	ARXB09LALH	ARXB12LALH	ARXB14LALH	ARXB18LALH	
Power source			230V ~, 50Hz					
Capacity	Cooling	kW	2.2	2.8	3.6	4.5	5.6	
	Heating		2.8	3.2	4.1	5.0	6.3	
Input power		W	46	55	63	90	96	
Airflow rate	High	m³/h	370	440	590	800	890	
	Med		310	370	500	750	810	
	Low		280	340	450	700	730	
Static pressure range		Pa	0 to 50	0 to 50	0 to 50	0 to 50	0 to 50	
Standard static pressure			25	25	25	25	25	
Sound pressure level	High	dB(A)	29	31	30	33	36	
	Med		26	29	28	32	34	
	Low		24	27	25	30	30	
Dimensions (H x W x D)		mm	217 x 663 x 595			217 x 953 x 595		
Weight		kg	18			25		
Connection pipe diameter	Liquid (Flare)	mm	ø6.35				ø9.52	
	Gas (Flare)		ø12.70				ø15.88	
	Drain		ø25 (I.D.) ; ø32 (O.D.)					

Note : Specifications are based on the following conditions.
Cooling : Indoor temperature of 27°CDB / 19°CWB, and outdoor temperature of 35°CDB / 24°CWB.
Heating : Indoor temperature of 20°CDB / (15°CWB), and outdoor temperature of 7°CDB / 6°CWB.
Pipe length : 7.5 m; Height difference between outdoor unit and indoor unit : 0 m.

Compact design

Ultra-slim duct air conditioner for easy installation

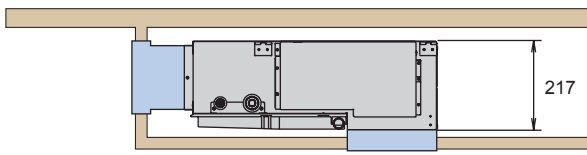

Slim size (217mm) allows installation even where the space behind the ceiling is narrow.

Two-direction drain piping

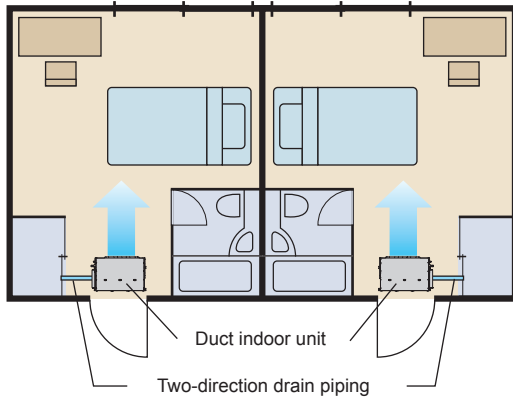

Air-intake

Air intake direction can be selected to match the installation site.

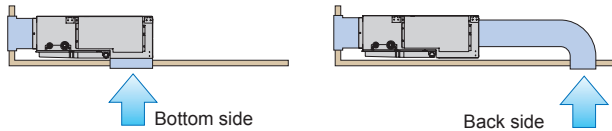

Flexible installation

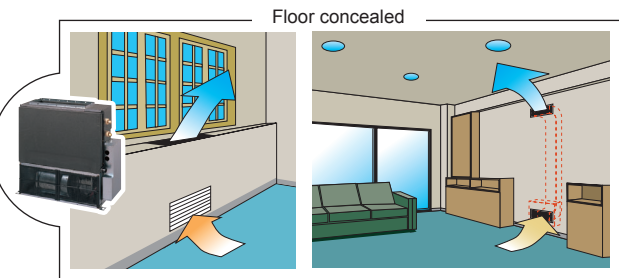
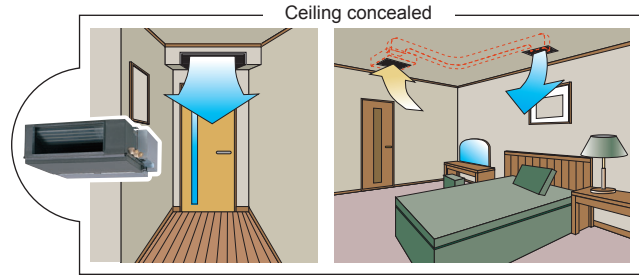

Filter (Accessory)

ARXB07 / ARXB09

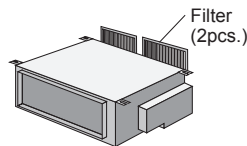

ARXB12 / ARXB14 / ARXB18

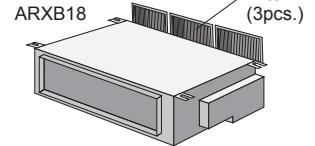

Optional parts

Remote Sensor Unit UTD-RS100
IR Receiver Unit UTB-*WB
Drain Pump Unit UTZ-PX1BBA
*WB : YWB, TWB

Dimensions

Models: ARXB07 / ARXB09 / ARXB12 / ARXB14 / ARXB18

*Service accessibility must be allowed for when installing the product.

Please consult the installation manual for the necessary service access size.

(Unit : mm)

() : AR7 / AR9

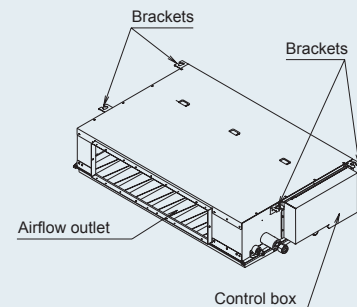
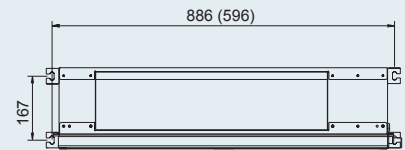
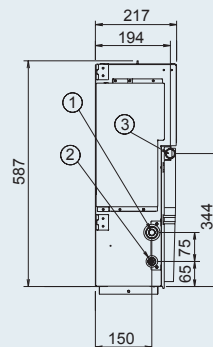
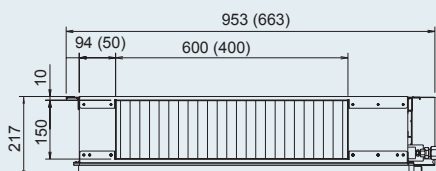
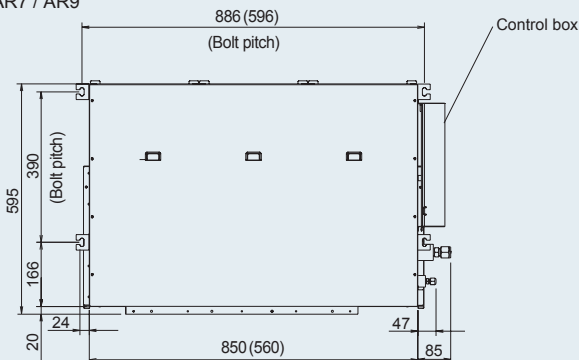

- ① Refrigerant piping flare connection (Gas)
- ② Refrigerant piping flare connection (Liquid)
- ③ Drain piping connection

Low Static Pressure Duct

Indoor units suitable for quiet rooms such as a hotel or a bedroom

Models

- ARXB24LATH**
- ARXB30LATH**
- ARXB36LATH**
- ARXB45LATH**

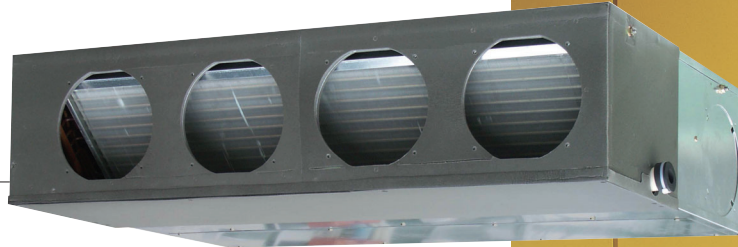

Duct

Slim Compact design allows for easy installation in narrow ceiling spaces up to 270mm

Models

- ARXA24LATH**
- ARXA30LATH**
- ARXA36LATH**
- ARXA45LATH**

Slim & Compact design

In the case of bottom return air connection, not only does the indoor unit design allow for installation in a narrow ceiling space of up to 270mm, Further space savings have been achieved by mounting the electrical control box internally inside the chassis.

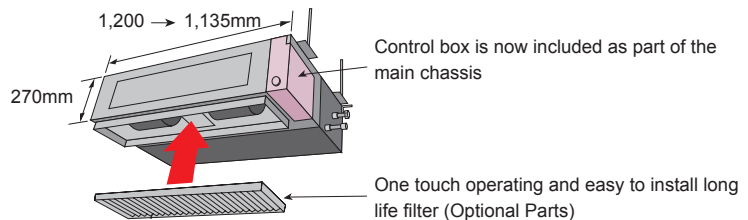

Specifications

Model name			ARXB24LATH	ARXB30LATH	ARXB36LATH	ARXB45LATH	ARXA24LATH	ARXA30LATH	ARXA36LATH	ARXA45LATH
Power source			230V ~, 50Hz				230V ~, 50Hz			
Capacity	Cooling	kW	7.1	9.0	11.2	12.5	7.1	9.0	11.2	12.5
	Heating		8.0	10.0	12.5	14.0	8.0	10.0	12.5	14.0
Input power		W	145	198	253	338	190	188	312	312
Airflow rate	High	m ³ /h	1,100	1,410	1,710	1,970	1,280	1,280	1,720	1,720
	Med		920	1,280	1,600	1,790	1,210	1,210	1,670	1,670
	Low		810	1,150	1,470	1,670	1,130	1,130	1,600	1,600
Static pressure range		Pa	0 to 80	0 to 80	0 to 80	0 to 80	30 to 150	30 to 150	30 to 150	30 to 150
Standard static pressure			40	50	50	60	100	100	100	100
Sound pressure level	High	dB(A)	31	34	37	41	38	40	43	43
	Med		27	32	35	38	36	38	41	41
	Low		25	29	33	36	34	36	39	39
Dimensions (H x W x D)		mm	270x1,135x700				270x1,135x700			
Weight		kg	43	45			43	45		
Connection pipe diameter	Liquid (Flare)	mm	ø9.52				ø9.52			
	Gas (Flare)		ø15.88		ø19.05		ø15.88		ø19.05	
	Drain		ø25 (I.D.); ø32 (O.D.)				ø25 (I.D.); ø32 (O.D.)			

Note : Specifications are based on the following conditions.
 Cooling : Indoor temperature of 27°CDB / 19°CWB, and outdoor temperature of 35°CDB / 24°CWB.
 Heating : Indoor temperature of 20°CDB / (15°CWB), and outdoor temperature of 7°CDB / 6°CWB.
 Pipe length : 7.5 m; Height difference between outdoor unit and indoor unit : 0 m.

Line-up of low-noise and high-power models, compatible with a wide range of static pressure

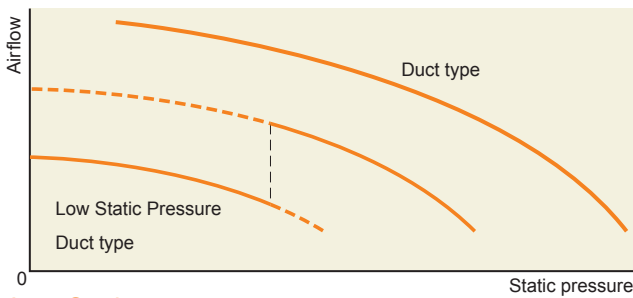

Low Static Pressure Duct type

Optimum model for hotels or bedrooms

An ultra low-noise model that achieves a quiet interior. Perfect for hotels or bedrooms with limited air duct installation space. Two different levels can be selected according to the static pressure range.

25dB

ARXB24
Low

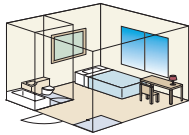

Duct type

Powerful model with a flexible design

With a powerful motor, appropriate for a wide range of static pressure. Flexible air duct installation is possible in a large space such as an office.

Max. 150Pa



Two-direction drain piping

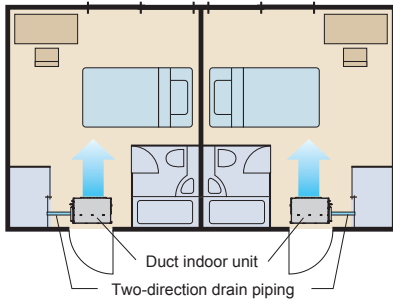

Easy maintenance

See below for the case of rear suction type

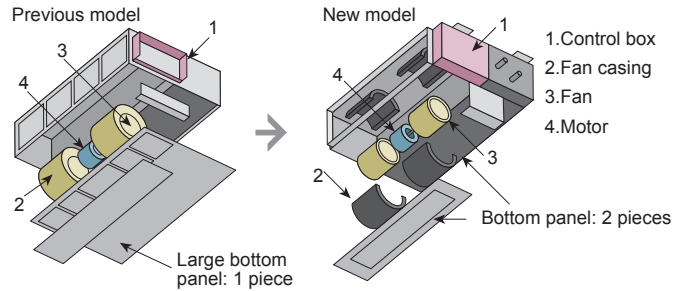

Structural improvement is attained by making the bottom panel two pieces, front and rear. The internal fan casing is also manufactured in two pieces, namely upper and lower. The maintenance of the motor and fan can be easily carried out by removing the rear panel and the lower part of the casing while leaving the main chassis installed.

Installation styles

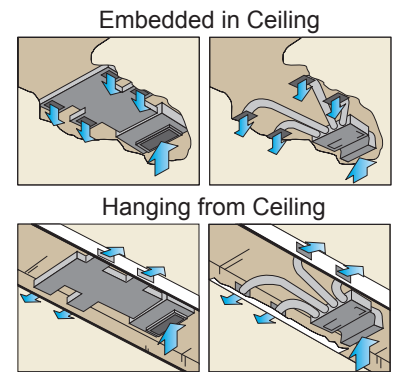

Optional parts

Remote Sensor Unit	UTD-RS100
Long Life Filter	UTD-LF25NA
Flange (Square)	UTD-SF045T
Flange (Round)	UTD-RF204
IR Receiver Unit	UTB- *WB
Drain Pump Unit	UTZ-PX1NBA
*WB : YWB, TWB	

Dimensions

Models: ARXB24 / ARXB30 / ARXB36 / ARXB45
ARXA24 / ARXA30 / ARXA36 / ARXA45

*Service accessibility must be allowed for when installing the product.

Please consult the installation manual for the necessary service access size.
(Unit : mm)

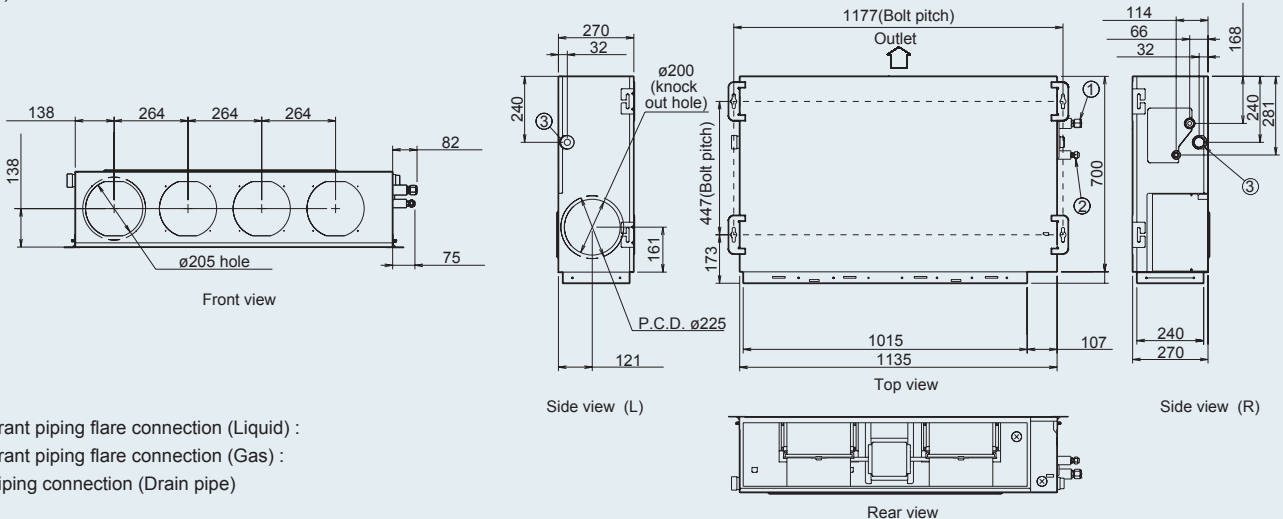

- ① Refrigerant piping flare connection (Liquid) :
- ② Refrigerant piping flare connection (Gas) :
- ③ Drain piping connection (Drain pipe)

High Static Pressure Duct

These indoor units allow for high airflow quantities

Models

ARXC36LATH
ARXC45LATH
ARXC60LATH



Models

ARXC72LATH
ARXC90LATH



Specifications

Model name			ARXC36LATH	ARXC45LATH	ARXC60LATH	ARXC72LATH	ARXC90LATH
Power source			230V ~, 50Hz				
Capacity	Cooling	kW	11.2	12.5	18.0	22.4	25.0
	Heating		12.5	14.0	20.0	25.0	28.0
Input power		W	405	427	427	1,110	1,250
Airflow rate	High	m³/h	2,600	3,500	3,500	3,900	4,300
	Med		1,950	3,000	3,000	3,300	4,000
	Low		1,450	2,460	2,460	3,000	3,500
Static pressure range		Pa	100 to 200	100 to 250	100 to 250	50 to 300	100 to 300
Standard static pressure			100	100	100	260	250
Sound pressure level	High	dB(A)	45	49	49	51	53
	Med		38	45	45	48	51
	Low		32	42	42	45	49
Dimensions (H x W x D)		mm	400 x 1,050 x 500			450 x 1,550 x 700	
Weight		kg	45	47		82	85
Connection pipe diameter	Liquid	mm	ø9.52 (Flare)			ø12.70 (Brazing)	
	Gas		ø19.05 (Flare)			ø22.22(Brazing)	
	Drain		ø25 (I.D.) ; ø32 (O.D.)				

Note : Specifications are based on the following conditions.
Cooling : Indoor temperature of 27°CDB / 19°CWB, and outdoor temperature of 35°CDB / 24°CWB.
Heating : Indoor temperature of 20°CDB / (15°CWB), and outdoor temperature of 7°CDB / 6°CWB.
Pipe length : 7.5 m; Height difference between outdoor unit and indoor unit : 0 m.

Easy installation (Compact size & Lightweight)

Models : ARXC36

A compact size and lightweight indoor unit has been developed by reducing the basic chassis and the overall material weight.

Volume
47.5%
down

Weight
40%
down

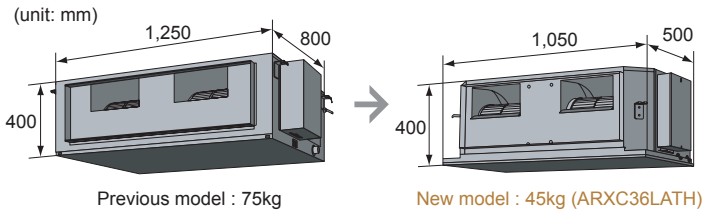

Low noise

Models : ARXC36 / ARXC45 / ARXC60

Cutting off the corners of the conventional indoor unit front panel and fan casing, has enabled less turbulent air flow. Low noise is realized by adopting a plastic case and a plastic fan.

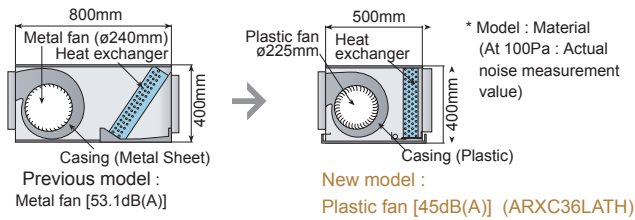
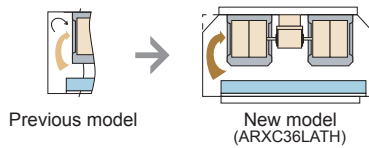

Static pressure selection : ARXC72/ARXC90

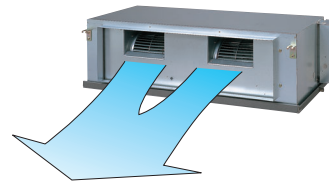

Max.
300Pa

2 Types of static pressure mode are selectable.

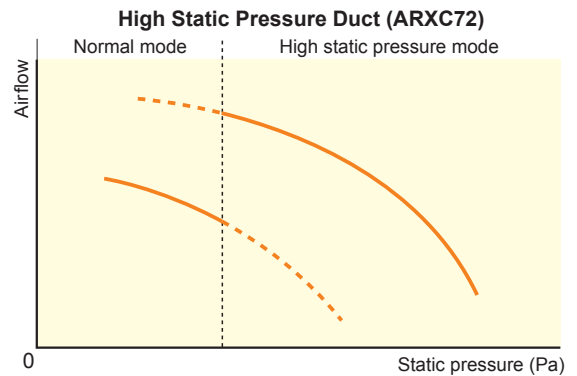

The adoption of a single phase fan motor allows 3 steps fan speed control

Optional parts

Long-Life Filter UTD-LF60KA (For ARXC36 / 45 / 60)
IR Receiver Unit UTB-★WB
★WB : YWB, TWB

Dimensions

Models: ARXC36 / ARXC45 / ARXC60
(Unit : mm)

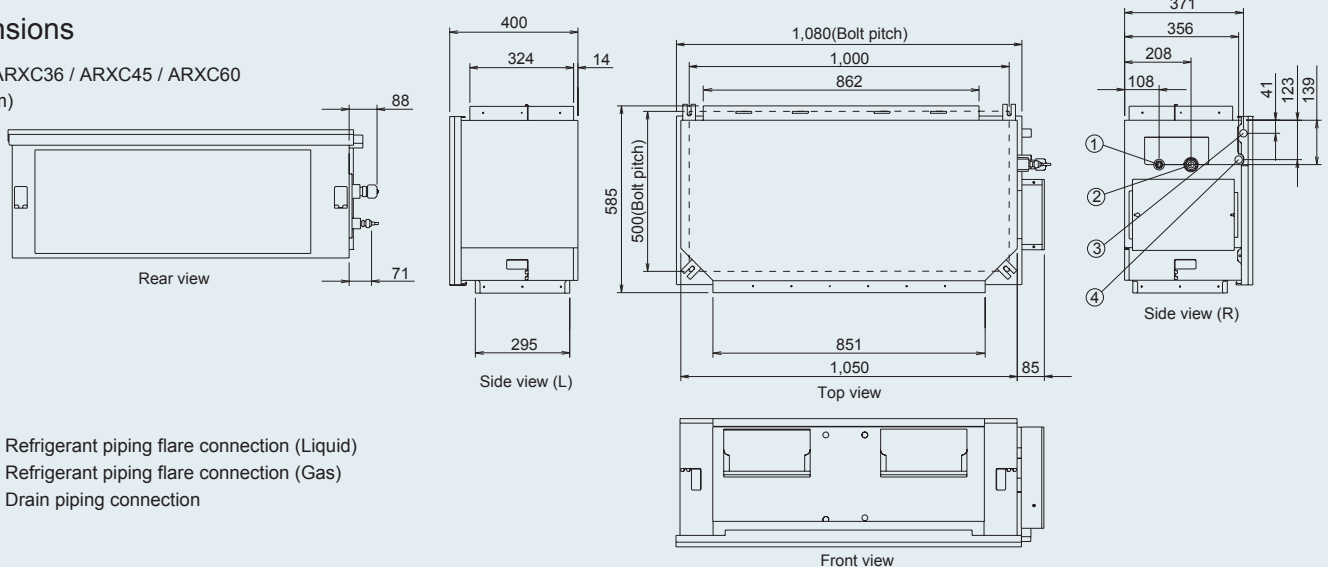

Models: ARXC72 / ARXC90
(Unit : mm)

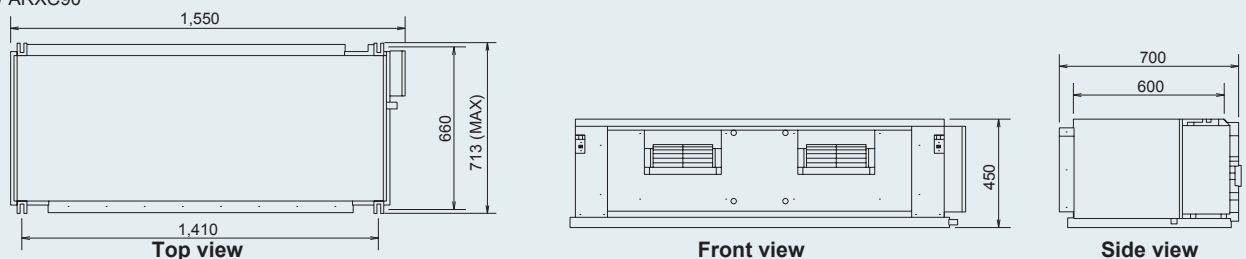

Floor / Ceiling

The slim and lightweight design allows the unit to be suspended from the ceiling or installed on the floor. This type suits many room designs

Models

- AB*A12LATH**
- AB*A14LATH**
- AB*A18LATH**
- AB*A24LATH**



Flexible installation

Example for floor installation

Floor console



Example for ceiling installation

Under ceiling



Specifications

Model name			AB*A12LATH	AB*A14LATH	AB*A18LATH	AB*A24LATH
Power source			230V ~, 50Hz			
Capacity	Cooling	kW	3.6	4.0	5.6	7.1
	Heating		4.1	4.5	6.3	8.0
Input power		W	57	57	88	88
Airflow rate	High	m³/h	600	600	780	880
	Med		500	500	650	740
	Low		480	480	550	630
Sound pressure level	High	dB(A)	40	40	46	48
	Med		37	37	41.5	44
	Low		34	34	37	40
Dimensions (H x W x D)		mm	199 x 990 x 655			
Weight		kg	28			
Connection pipe diameter	Liquid (Flare)	mm	ø6.35		ø9.52	
	Gas (Flare)		ø12.70		ø15.88	
	Drain		ø25 (I.D.) ; ø32 (O.D.)			

AB*: ABY(FUJITSU), ABH(GENERAL)

Note : Specifications are based on the following conditions.

Cooling : Indoor temperature of 27°CDB / 19°CWB, and outdoor temperature of 35°CDB / 24°CWB.

Heating : Indoor temperature of 20°CDB / (15°CWB), and outdoor temperature of 7°CDB / 6°CWB.

Pipe length : 7.5 m; Height difference between outdoor unit and indoor unit : 0 m.

Voltage : 230 [V].

Double auto swing

A combination of up/down and right/left directional swing allows three-dimensional air direction control.

RIGHT and LEFT SWING

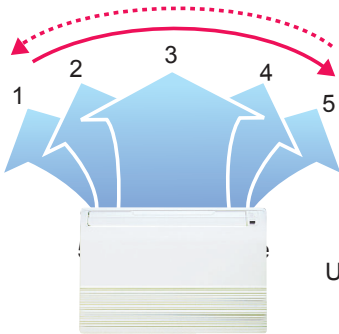

UP and DOWN SWING

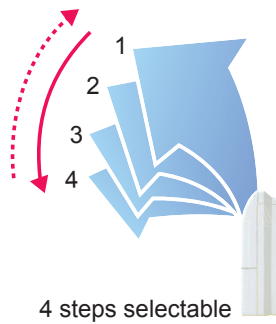

Super vane

Double Louvre Super vane with newly developed special configuration boosts airflow sending cool air quickly to every corner of the room.

Auto-closing louvre

When operation is stopped, the louvres will automatically close. (This function is available on all non-ducted models.)

Compact design

Symmetrical, slim and compact design.

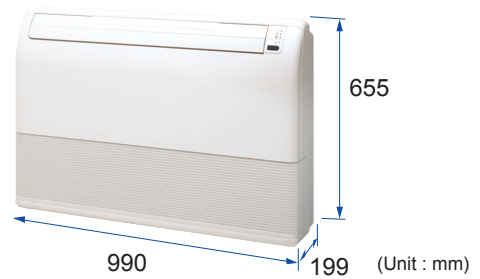

Dimensions

Models: AB*A12 / AB*A14 / AB*A18 / AB*A24
(Unit : mm)

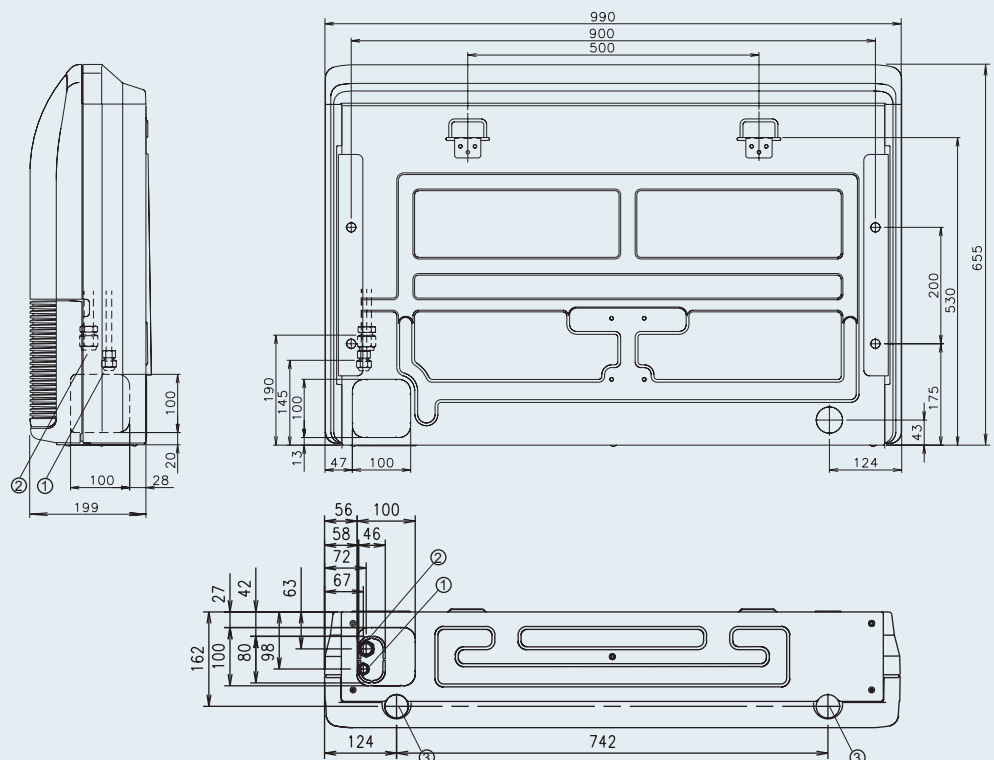

- ① Refrigerant piping flare connection (Liquid)
- ② Refrigerant piping flare connection (Gas)
- ③ Drain piping connection

Ceiling

Easily concealed in any installation

Models

- AB*A30LATH**
- AB*A36LATH**
- AB*A45LATH**
- AB*A54LATH**



Installation

Open

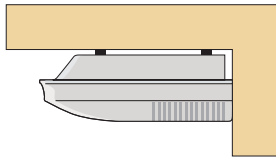

General installation pattern which suspends the indoor unit from the ceiling.

Concealed

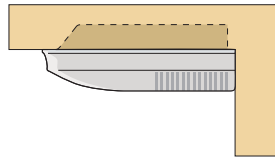

Installation pattern where part of the indoor unit is embedded into the ceiling.

Wall mounted

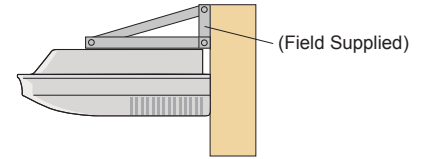

Installation which fixes the indoor unit to the wall by the use of wall brackets (Field supplied). This type of installation can be used when the ceiling space is insufficient.

Specifications

Model name			AB*A30LATH	AB*A36LATH	AB*A45LATH	AB*A54LATH
Power source			230V ~, 50Hz			
Capacity	Cooling	kW	9.0	11.2	12.5	14.0
	Heating		10.0	12.5	14.0	16.0
Input power		W	124	144	160	180
Airflow rate	High	m ³ /h	1,450	1,660	1,850	2,200
	Med		1,280	1,500	1,660	2,000
	Low		980	1,270	1,430	1,800
Sound pressure level	High	dB(A)	42	45	48	52
	Med		39	42	46	50
	Low		35	37	41	46
Dimensions (H x W x D)		mm	240 x 1,660 x 700			
Weight		kg	48			
Connection pipe diameter	Liquid (Flare)	mm	ø9.52			
	Gas (Flare)		ø15.88	ø19.05		
	Drain		ø25 (I.D.) ; ø32 (O.D.)			

AB*: ABY(FUJITSU), ABH(GENERAL)

Note : Specifications are based on the following conditions.

Cooling : Indoor temperature of 27°CDB / 19°CWB, and outdoor temperature of 35°CDB / 24°CWB.

Heating : Indoor temperature of 20°CDB / (15°CWB), and outdoor temperature of 7°CDB / 6°CWB.

Pipe length : 7.5 m; Height difference between outdoor unit and indoor unit : 0 m.

Voltage : 230 [V].

Double auto swing and wide airflow

Auto airflow direction and auto swing

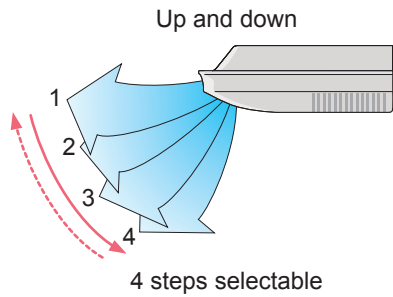
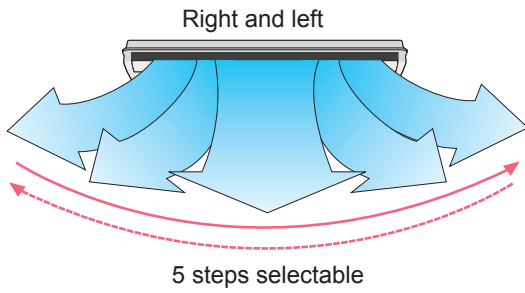

Long Airflow

Long Airflow ensures comfort to every corner of a large room.

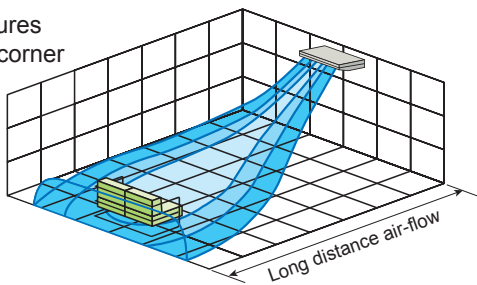

Slim & Compact design



Condensate lift-up mechanism (Option)

Optional drain lift-up mechanism allows flexible installation.

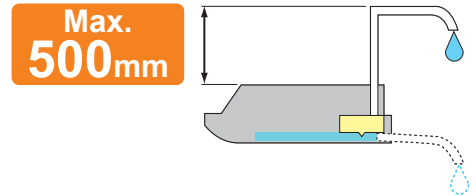

Fresh air intake

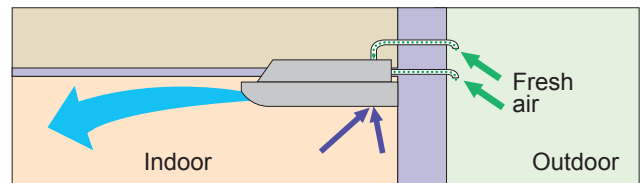

Long-life filter

High Efficiency long-life filter doubles the life of the filter compared to standard filters.

Optional parts

Drain Pump Unit UTR-DPB24T

Dimensions

Models: AB*A30 / AB*A36 / AB*A45 / AB*A54
(Unit : mm)

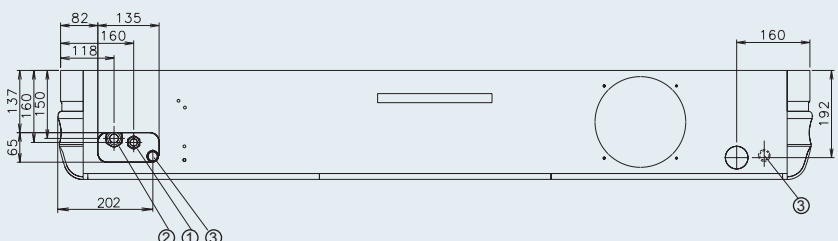
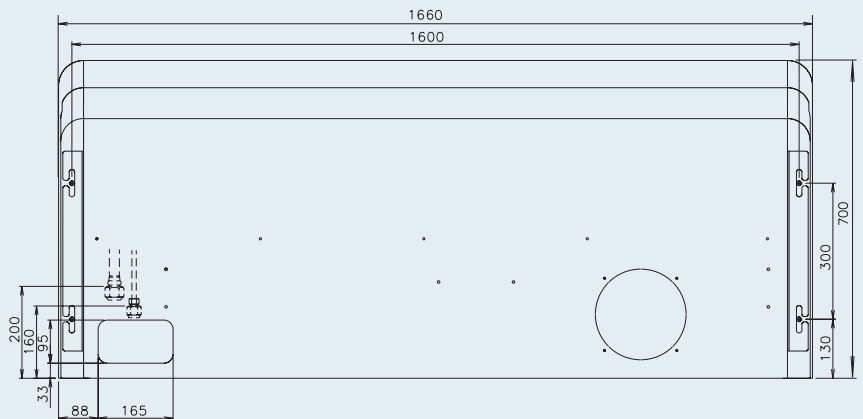
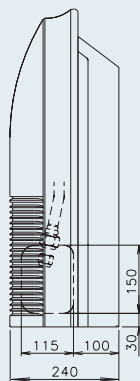

- ① Refrigerant piping flare connection (Liquid)
- ② Refrigerant piping flare connection (Gas)
- ③ Drain piping connection

Compact Wall Mounted

Compact and Stylish design indoor



Models

(EEV internal model)	(EEV external model)
AS*A07LACH	AS*E07LACH
AS*A09LACH	AS*E09LACH
AS*A12LACH	AS*E12LACH
AS*A14LACH	AS*E14LACH



Filter features



Apple-catechin filter

Fine dust, invisible mold spores, and harmful microorganisms are absorbed onto the filter by static electricity, and further growth is inhibited and deactivated by the polyphenol ingredient extracted from apples.



Long-life* Ion deodorization filter

The filter deodorizes by powerfully decomposing absorbed odors using the oxidizing and reducing effects of ions generated by the ultra-fine-particle ceramic.



Deodorizing effect (Odor reduction rate)

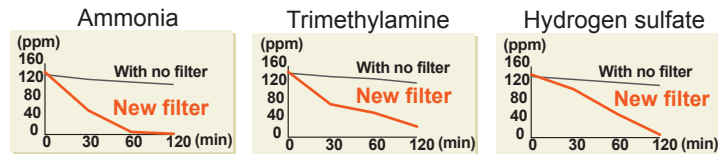

Testing organization : Environmental Sanitary Inspection Center Test method : Deodorization Test

* The filter can be used for approx. 3 years if it is washed under water to restore its surface action when it is dirty.

Specifications

Model name			AS*A07LACH	AS*A09LACH	AS*A12LACH	AS*A14LACH	AS*E07LACH	AS*E09LACH	AS*E12LACH	AS*E14LACH
Power source			230V ~, 50Hz				230V ~, 50Hz			
Capacity	Cooling	kW	2.2	2.8	3.6	4.5	2.2	2.8	3.6	4.5
	Heating		2.8	3.2	4.1	5.0	2.8	3.2	4.1	5.0
Input power			16	16	19	30	15	16	20	28
Airflow rate	High	m ³ /h	490	500	560	670	490	500	560	680
	Med		450	450	480	490	450	450	480	490
	Low		370	370	420	420	370	370	420	420
Sound pressure level	High	dB(A)	35	36	39	44	34	35	38	43
	Med		33	33	35	37	32	32	34	35
	Low		27	27	31	32	26	26	30	30
Dimensions (H x W x D)			275 x 790 x 215				275 x 790 x 215			
Weight			9				9			
Connection pipe diameter	Liquid (Flare)	mm	ø6.35				ø6.35			
	Gas (Flare)		ø12.70				ø12.70			
	Drain		ø13.8(I.D.) ; ø15.8-ø16.7(O.D.)				ø13.8(I.D.) ; ø15.8-ø16.7(O.D.)			
EV Kit (option)			-				UTR-EV09XB		UTR-EV14XB	

AS*: ASY(FUJITSU), ASH(GENERAL)

Note : Specifications are based on the following conditions.

Cooling : Indoor temperature of 27°CDB / 19°CWB, and outdoor temperature of 35°CDB / 24°CWB.

Heating : Indoor temperature of 20°CDB / (15°CWB), and outdoor temperature of 7°CDB / 6°CWB.

Pipe length : 7.5 m; Height difference between outdoor unit and indoor unit : 0 m.

Voltage : 230 [V].

Low noise

27dB

(AS07/09)

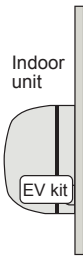

Electronic Expansion valves are built-in allowing for easy installation.

For installation to places that require additional low noise, select the external electronic expansion valve type.

Compact size

Powerful output even compact design

Though the indoor unit is compact, it features a large, high pressure cross fan (90mm diameter) in a centre mounted configuration and a Lambda type heat exchanger to provide plenty of power.

Width 790mm

Symmetrical design

Symmetrical, clean design that suits all interiors.



New Style High Power DC fan motor

- High power
- Wide rotation range
- High efficiency
- Compact size



Auto swing louvre

The Auto Swing Louvre function ensures that the air direction corresponds to the mode selected.

- Step
- - - - - Swing

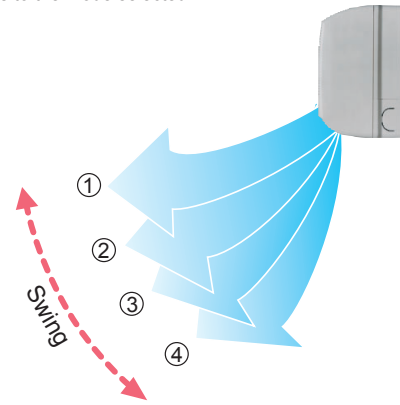

Easy maintenance

Easy maintenance has been realized as the front panel can be removed for easy access.

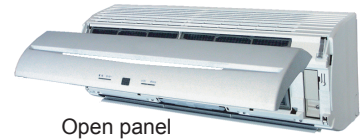

Wired control compatible



Wired and Wireless Remote Controller are acceptable.



Wired Remote Controller



Simple Remote Controller

Dimensions

Models: AS*A07 / AS*A09 / AS*A12 / AS*A14
AS*E07 / AS*E09 / AS*E12 / AS*E14

(Unit : mm)

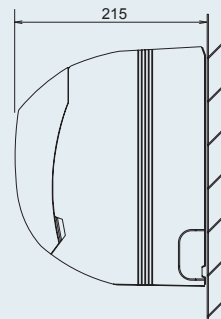
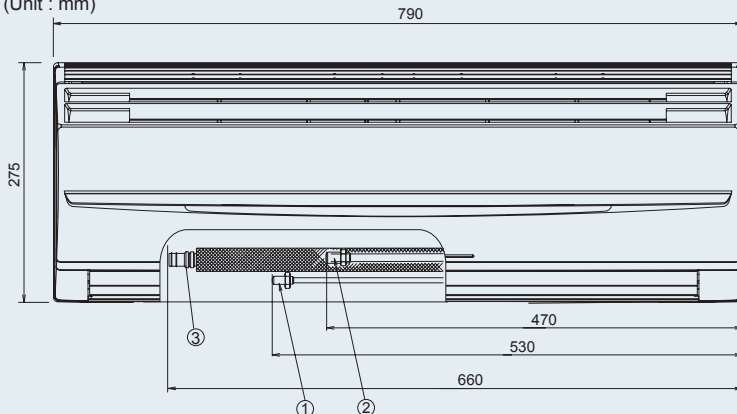

- ① Refrigerant pipe flare connection (Liquid)
- ② Refrigerant pipe flare connection (Gas)
- ③ Drain piping connection

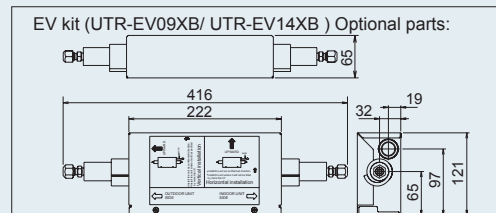

Wall Mounted

Double auto swing louver provides pleasant air flow to every corner of the room

Models

- AS*A18LATH**
- AS*A24LATH**
- AS*A30LATH**



Powerful output in spite of small size

Though the indoor unit is compact, it features a large, high pressure cross fan (107mm diameter) in a center mounted configuration and a lambda type heat exchanger to provide plenty of power. The extra long diffuser provides a wide outflow opening for air. This ensures a large air outflow volume over a wide area to cool or heat all areas of the room.



Specifications

Model name			AS*A18LATH	AS*A24LATH	AS*A30LATH
Power source			230V ~, 50Hz		
Capacity	Cooling	kW	5.6	7.1	8.0
	Heating		6.3	8.0	8.8
Input power		W	63	74	73
Airflow rate	High	m ³ /h	870	940	980
	Med		700	720	870
	Low		540	600	750
Sound pressure level	High	dB(A)	43	45	45
	Med		37	39	42
	Low		30	33	39
Dimensions (H x W x D)		mm	320 x 1,120 x 220		
Weight		kg	16		
Connection pipe diameter	Liquid (Flare)	mm	ø9.52		
	Gas (Flare)		ø15.88		
	Drain		ø12 (I.D.) ; ø16 (O.D.)		

AS*: ASY(FUJITSU), ASH(GENERAL)
 Note : Specifications are based on the following conditions.
 Cooling : Indoor temperature of 27°CDB / 19°CWB, and outdoor temperature of 35°CDB / 24°CWB.
 Heating : Indoor temperature of 20°CDB / (15°CWB), and outdoor temperature of 7°CDB / 6°CWB.
 Pipe length : 7.5 m; Height difference between outdoor unit and indoor unit : 0 m.
 Voltage : 230 [V].

Multi airflow

Large independently driven power diffuser used

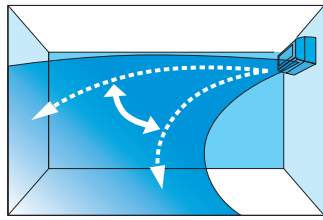

Cooling

Horizontal concentration and other air direction control

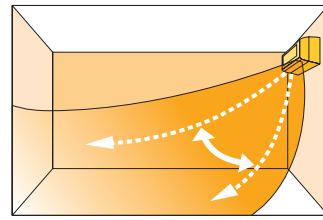

Heating

Wide down flow

Steps
Swing

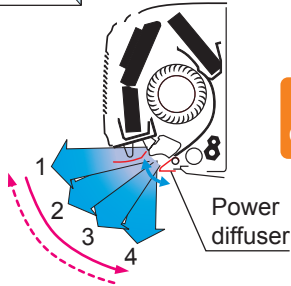

Large independently driven power diffuser

Steps
Swing

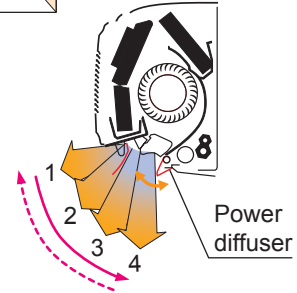

Low noise

- High efficiency fan construction ⇒ ø7mm Lambda type evaporator improves the airflow path
- Large independently driven power diffuser

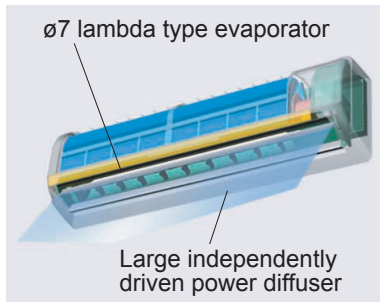

Low noise
30dB
(AS18)

Easy installation

Expanded work space at bottom of casing increases piping space by 15%.

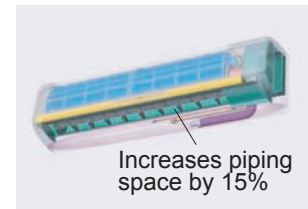

Others

- Double auto swing
- 2-way draining route

Dimensions

Models: AS*A18 / AS*A24 / AS*A30
(Unit : mm)

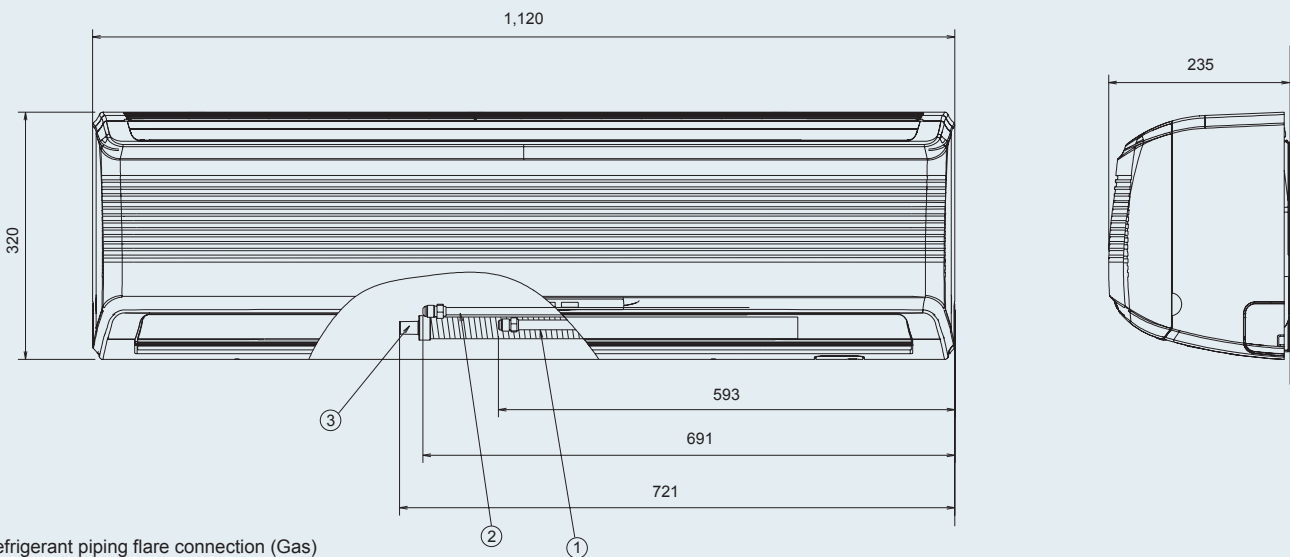

- ① Refrigerant piping flare connection (Gas)
- ② Refrigerant piping flare connection (Liquid)
- ③ Drain piping connection

Control System

The V-II system supports every users needs by offering a variety of Control systems, including individual control, central control and building management control options.

System Diagram

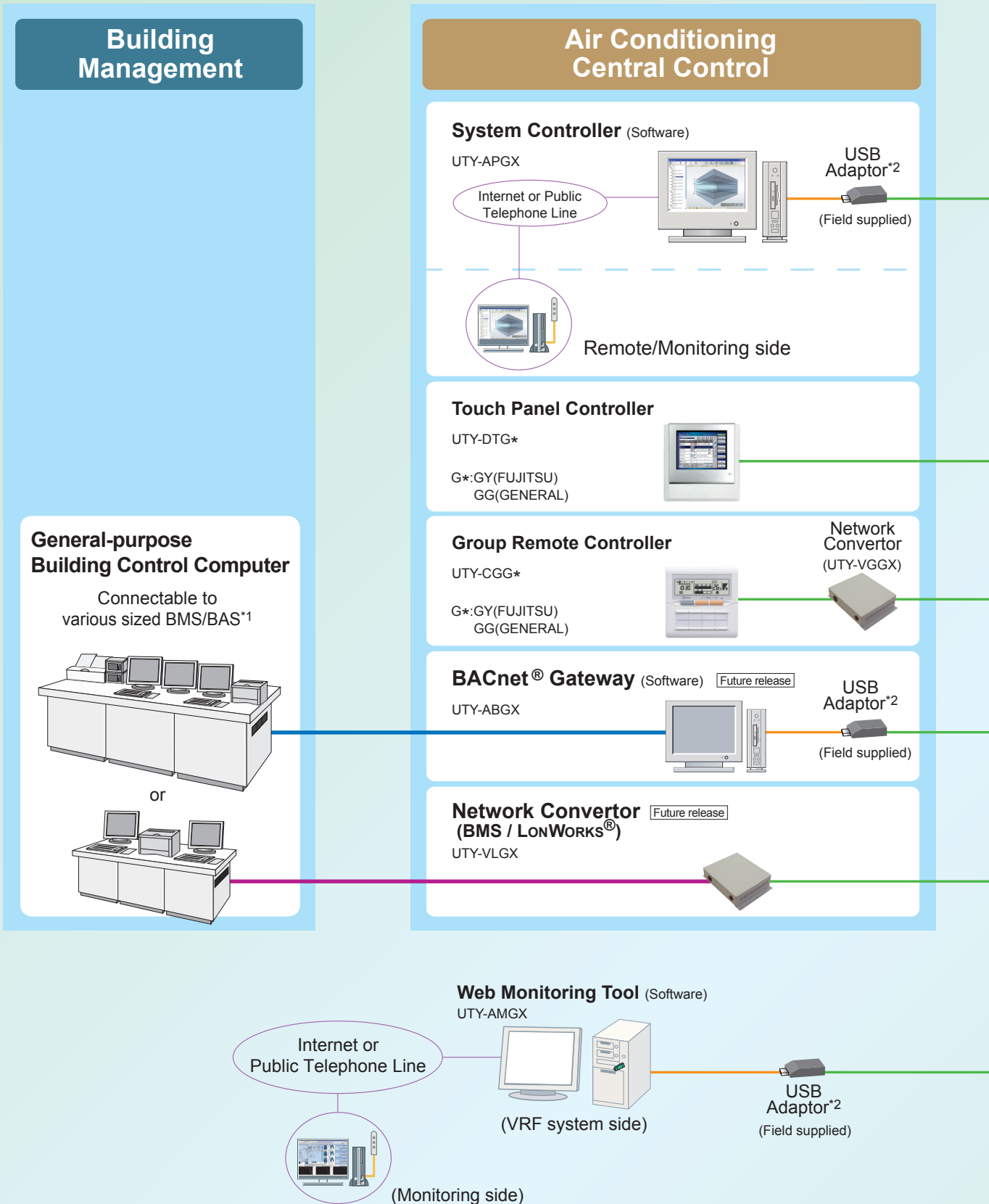

*1. BMS/BAS: Building Management System / Building Automation System
 *2. USB Adaptor is U10 USB Network Interface of Echelon® Corporation.

The device above cannot be connected to the S or V series. (Except System Controller)

Air Conditioning Individual Control

Wired Remote Controller

UTY-RNK*

K*:KY(FUJITSU),KYT(FUJITSU)
KG(GENERAL)



Simple Remote Controller

UTY-RSK*

K*:KY(FUJITSU),KYT(FUJITSU)
KG(GENERAL)



Simple Remote Controller

UTY-RHK*

K*:KY(FUJITSU),KYT(FUJITSU)
KG(GENERAL)



Wireless Remote Controller

UTY-LNH*

H*:HY(FUJITSU)
HG(GENERAL)



Card-key

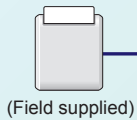

External Switch Controller

UTY-TEKX



Service Tool (Software)

UTY-ASGX



System

Outdoor unit



Indoor unit

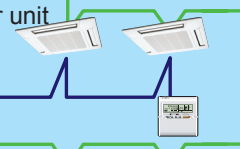

Signal Amplifier

UTY-VSGX

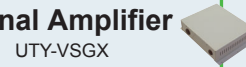

IR Receiver Unit

UTB-*WB

*WB:YWB, TWB



IR Receiver Kit

UTY-LRH*B1

*B:YB(FUJITSU)
GB(GENERAL)



For single split

Network Converter

UTY-VGGX

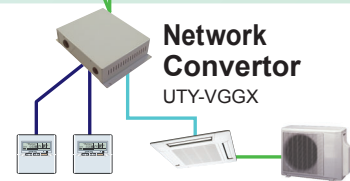

- Transmission line (VRF Network)
- LONWORKS Network
- Module link
- Ethernet
- Remote controller line
- Signal line(Single split system)
- USB cable
- Group Remote Controller line

Comparison table of Controllers

Item	Wired Remote Controller	Simple Remote Controller	Simple ¹ Remote Controller	Wireless Remote Controller	Group Remote Controller	Touch Panel Controller	System Controller (Software)
Model name	UTY-RNKY UTY-RHKYT UTY-RNKG	UTY-RSKY UTY-RSKYT UTY-RSKG	UTY-RHKY UTY-RHKYT UTY-RHKG	UTY-LNHY UTY-LNHG	UTY-CGGY UTY-CGGG	UTY-DTGY UTY-DTGG	UTY-APGX
Max. controllable remote controller groups	1	1	1	1	8	400	1600
Max. controllable indoor units	16	16	16	16	96	400	1600
Max. controllable groups	-	-	-	-	-	400	1600
Air conditioning control function	On / Off	●	●	●	●	●	●
	Operation mode setting	●	●	-	●	●	●
	Fan speed setting	●	●	●	●	●	●
	Room temp. setting	●	●	●	●	●	●
	Room temp. set point limitation	-	-	-	●	-	●
	Test operation	●	●	-	●	-	●
	Up/down air direction flap setting	●	-	-	●	-	●
	Right/left air direction flap setting	●	-	-	●	-	●
	Group setting	-	-	-	●	-	●
	RC prohibition	-	-	-	-	-	●
	Anti freeze setting	-	-	-	-	-	●
	Economy mode setting	●	-	-	●	-	●
Display	Failure	●	●	●	-	●	●
	Defrosting	●	●	●	●	-	●
	Current time	●	-	-	●	●	●
	Day of week	●	-	-	-	●	●
	R.C. prohibition	●	●	●	-	-	●
	Cooling/heating priority	●	●	●	-	●	●
	Address display	●	●	●	-	●	●
Timer	System schedule timer	-	-	-	-	●	●
	On/off per day	-	-	-	-	20	72
	On/off per week	-	-	-	-	140	504
	Weekly timer	●	-	-	-	●	-
	On/off per day	2	-	-	-	2	-
	On/off per week	14	-	-	●	14	-
	On/off timer	●	-	-	●	-	-
	Sleep timer	-	-	-	●	-	-
Program timer	-	-	-	●	-	-	
Day off	●	-	-	-	-	●	
Control	Min. unit of timer setting(Minutes)	30	-	-	5	10	10
	Status monitoring system	-	-	-	-	●	●
	Electricity charge calculation	-	-	-	-	-	●
	Error history	●	●	●	-	●	●
	Emergency stop	-	-	-	-	-	● ^{*2}
	Control via internet	-	-	-	-	-	●
	E-mail notification for malfunction	-	-	-	-	-	●

*1 "Operation mode" setting is not available for this model.

*2 This function is available only through external input. control.

Wired Remote Controller

UTY-RNK*

The room temperature can be controlled by detecting the temperature accurately from the built-in sensor

Max. controllable
16
indoor units

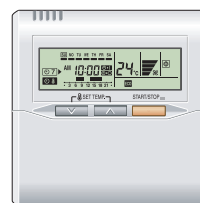

- Simple operation with Built-in Weekly / Daily Timer.
- Control up to 16 indoor units.
- Up to 2 wired remote controllers can be connected to a single indoor unit.

Functions

Powerful features and compact size

This Wired Remote Controller incorporates four primary functions into a single unit.

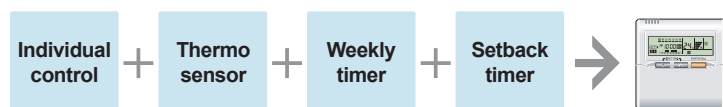

Accurate and comfortable

Indoor temperature can be detected accurately by the inclusion of a thermo sensor in the body of the wired controller.

This new wired remote controller and the optional remote sensor allows flexibility in sensor location, suitable for all requirements.

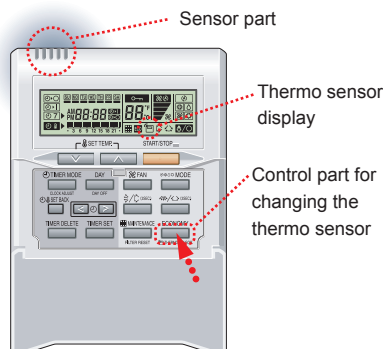

Example of changing sensor

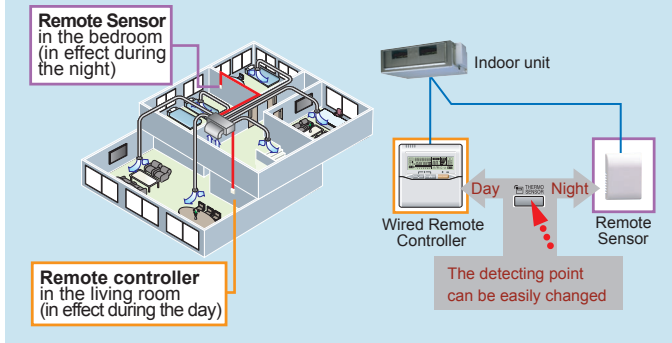

Displayed temperature is set temperature.

Built-in timers

Weekly timer :

Possible to set ON/OFF time to operate twice each day of the week.

Easy-to-understand time bar display



Setup screen example (Set to Wednesday: 8:00 to 20:00.)



Setback timer :

Possible to set temperature for two times spans and for each day of the week.



Setup screen example (Set from Sunday to Saturday: 12:00 to 15:00, 28°C.)

At "Weekly timer" + "Setback timer" setup



Diagnosis check function

Two methods are available for determining the cause of failure in the event of a malfunction occurs:

- Malfunction diagnosis function
- Error history (Last 16 error codes can be accessed)

Simple installation

Components are compatible with standard switch boxes. Flat back surface allows to be installed wherever it is needed.

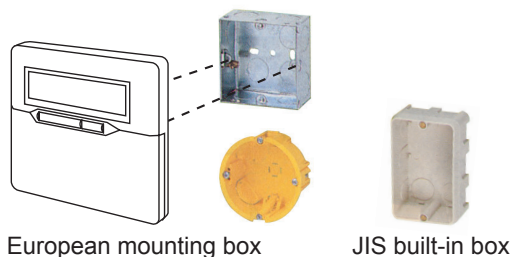

Specifications

Model name	UTY-RNK*
Power Supply	DC 12V
Dimensions (H x W x D) (mm)	120 x 120 x 17
Weight (g)	160

DC12V is supplied by the indoor unit.

K* : KY(FUJITSU), KYT(FUJITSU), KG(GENERAL)

Simple Remote Controller

UTY-RSK*

UTY-RHK* (Without Operation mode)

Compact remote controller provides access to basic functions

- Up to 16 indoor units can be controlled with one remote controller.
- Suitable for hotels or offices as it is easily operated with no complex functions.

Max. controllable
16
indoor units



UTY-RSK*



UTY-RHK*
Without Operation mode

Functions

User-friendly operation

- Provides access to basic operations, such as Start / Stop, Fan control, Operation mode switching, and Room temperature setting.
- A large On / Off button is provided in the centre of the remote controller for easy operation.
- Can be used jointly with other individual control unit.
- Following an error display, diagnostics can be carried out on the controller.

Background light

- Background light enables easy operation in a darkened room.
- Background light activates during all button operations, and lasts 10 seconds in Operation mode and 5 seconds in stop mode after a button is pressed.



Simple installation

Can be mounted on the European Mounting Box (Installation dimension: 60mm) or the JIS Built-in Box (Installation dimension: 83.5mm).

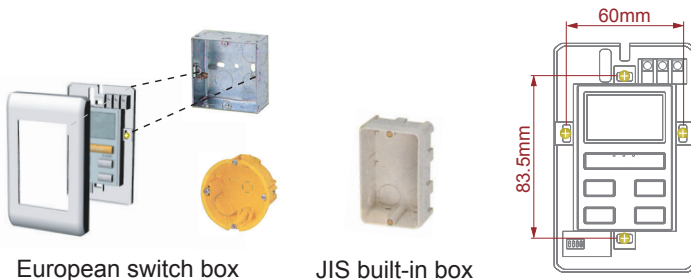

European switch box

JIS built-in box

Functions

Model	UTY-RSK*	UTY-RHK*
Operation		
On / Off	●	●
Fan control	●	●
Operation mode	●	—*1
Room temp. setting	●	●

*1: "Operation mode" setting is not available.

It is recommend to use together with other type controller.

Specifications

Model name	UTY-RSK*	UTY-RHK*
Power Supply	DC 12V	
Dimensions (H x W x D) (mm)	120 x 75 x 14	
Weight (g)	90 (100 : UTY-RSKYT)	90 (100 : UTY-RHKYT)

DC12V is supplied by the indoor unit.

K* : KY(FUJITSU), KYT(FUJITSU), KG(GENERAL)

Wireless Remote Controller

UTY-LNH*

Simple and sophisticated operations with a choice of 4 daily timers

- A single controller controls up to 16 indoor units.

Max. controllable
16
indoor units

Selectable
4
daily timers



Functions

Built-in daily timer

Select from 4 different timer programs : On / Off / Program / Sleep

Program timer : The program timer operates the ON and OFF timer once within a 24 hour period.

Sleep timer : The sleep timer function automatically corrects the set temperature according to the time setting to prevent excessive cooling or heating during sleep hours.

Cooling operation/dry operation

When the sleep timer is set, the set temperature automatically rises 1°C every hour. The set temperature can rise up to a maximum of 2°C.

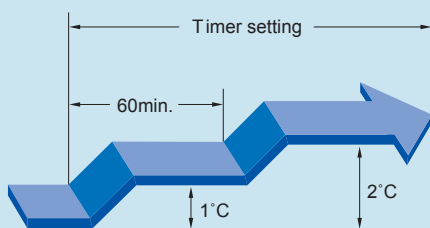

Heating operation

When the sleep timer is set, the set temperature automatically drops 1°C every 30 minutes. The set temperature can drop to a max. of 4°C.

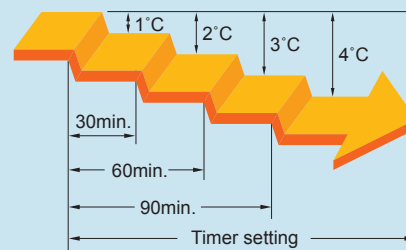

Easy installation and operation

- Code selector switch prevents indoor unit mix-up. (Up to 4 codes can be set.)

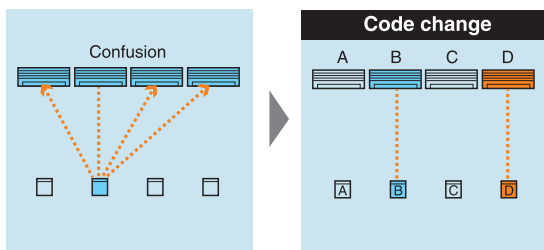

- Wide and precise transmitting range.



Address setting

- During installation work, address setting can be performed using the Wireless Remote Controller, thus eliminating manual switch setting.

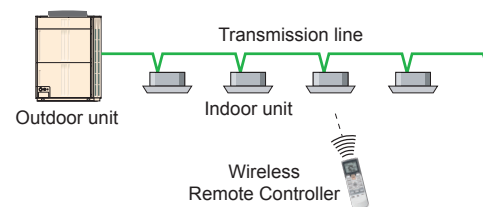

Specifications

Model name	UTY-LNH*
Battery	1.5V (R03 / LR03 / AAA) x 2
Dimensions (H x W x D) (mm)	158 x 56 x 20
Weight (g)	70

H* : HY(FUJITSU), HG(GENERAL)

IR Receiver Unit

UTB-*WB

Necessary to control for all duct type by Wireless Remote Controller



Wiring connection

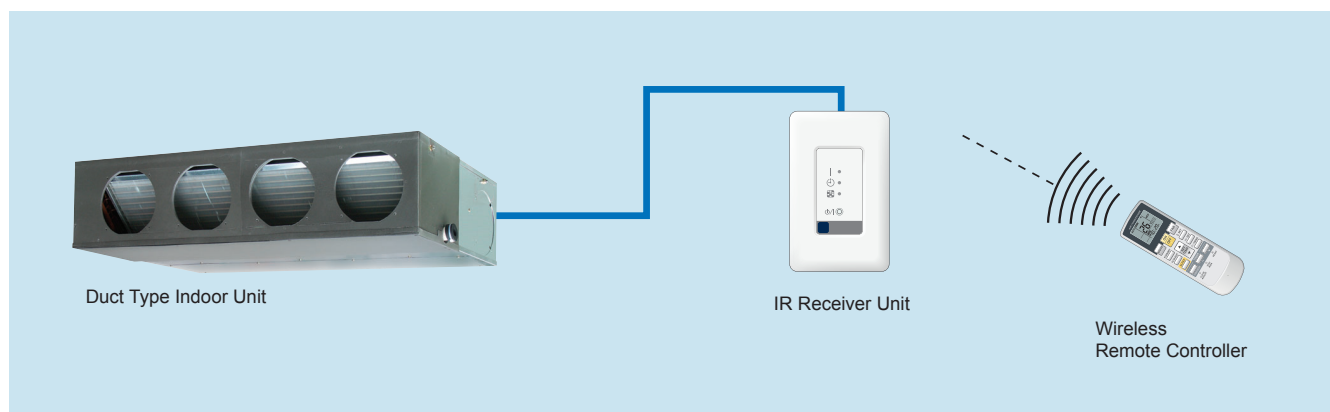

Specifications

Model name	UTB-*WB
Dimensions (H x W x D) (mm)	122 x 60 x 26.5
Weight (g)	150

*WB : YWB, TWB

IR Receiver Kit

UTY-LRH*B1

Cassette type indoor unit can be controlled with Wireless Remote Controller



Specifications

Model name	UTY-LRH*B1
Dimensions (H x W x D) (mm)	213.8 x 213.8x 25.7
Weight (g)	140

H* : HY(FUJITSU), HG(GENERAL)

Group Remote Controller

UTY-CGG*

Max. controllable
8
remote controller groups

Max. connectable
64
group R.C. in
a VRF network system

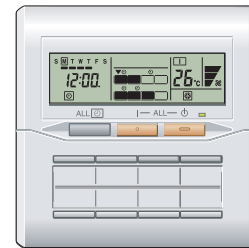

Group control of indoor units with simple operation

- Up to 8 remote controller groups can be controlled by one Group Remote Controller.
- Up to 64 Group Remote Controllers can be connected in one VRF network system.
- Network Converter (UTY-VGGX) is required to connect Group Remote Controllers to a VRF network system. (Network Converter allows up to 4 Group Remote Controllers)

Functions

High performance and compact size

ON / OFF, Operating mode, Room temperature and Fan speed setting can be controlled / monitored centrally or individually.



Control up to 8 remote controller groups

•Single Group Remote Controller controls and monitors up to 8 remote controller groups.

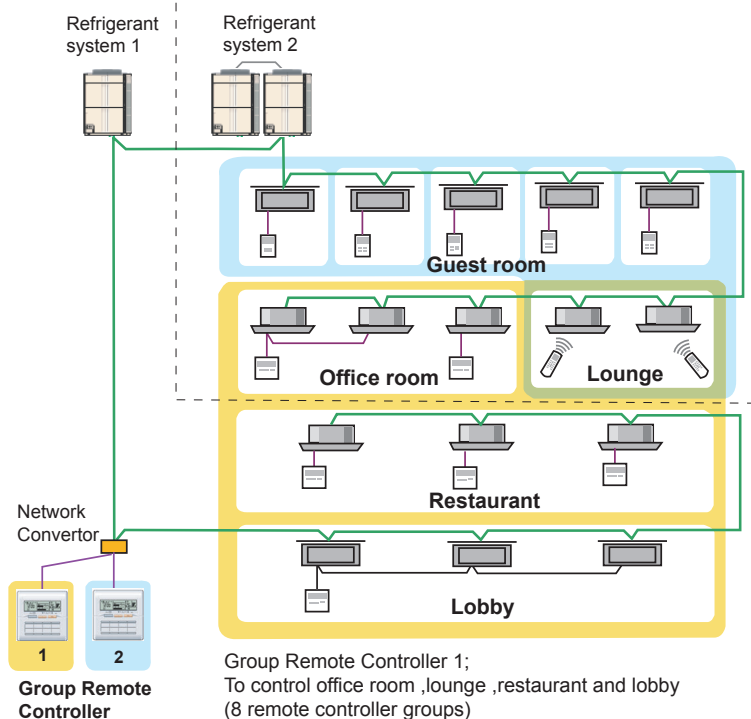
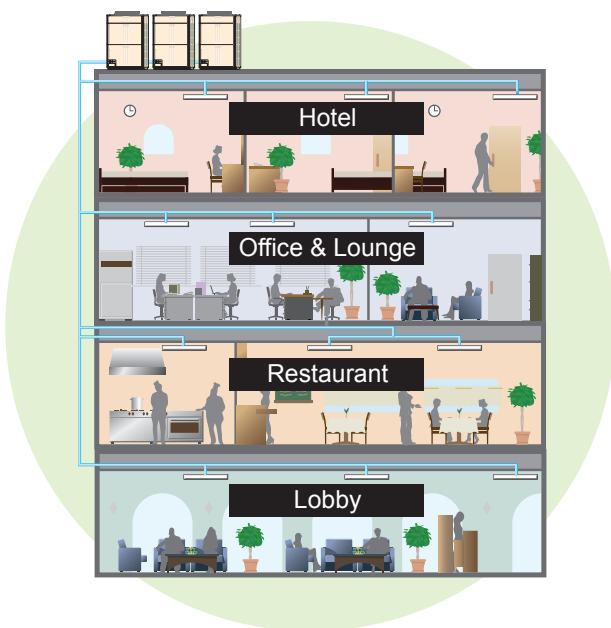

Group Remote Controller 1;
To control office room ,lounge ,restaurant and lobby
(8 remote controller groups)
Group Remote Controller 2;
To control guest room and lounge (7 remote controller groups)

Built-in weekly timers

The weekly timer is provided as a standard function.

1. The timer can be set up for up to 4 times per day. (On / Off, operating mode, set temperature)
2. Allows separate settings for each day of the week.

ON / OFF switching

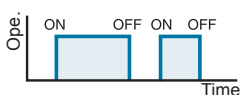

Air conditioning ON/OFF setting corresponding to air conditioning specification needs is possible.

Cooling / Heating switching

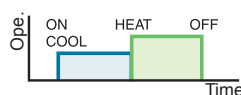

Switching between the cooling mode and heating mode can be set by time.

Temperature switching (Peak power cut)

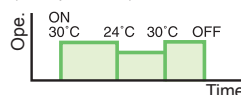

Since peak power cut is performed in a planned way, setting which changes the room temperature linked with time is possible.

Temperature switching (Anti-freeze)

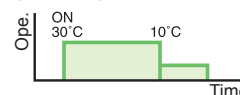

Low temperature heating operation can be set to prevent freezing in cold regions at night, etc.

Stop setting

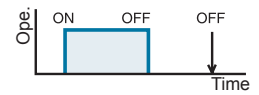

Indoor unit stop setting at operation end time is possible.

Useful functions

1 Timer setting at all the connected indoor units is possible by centralized timer on the front panel.

ALL TIMER Button

Press the ALL TIMER button to turn the timer operation on or off for all indoor units.

3 The indoor unit can be quickly turned on and off by ON / OFF button of each indoor unit on the front of the door.

Indoor Unit Name Labels

Write the names of the indoor units on the included labels and attach them.

ON / OFF Button

Press the ON / OFF button to turn the corresponding indoor unit on or off.

With cover closed

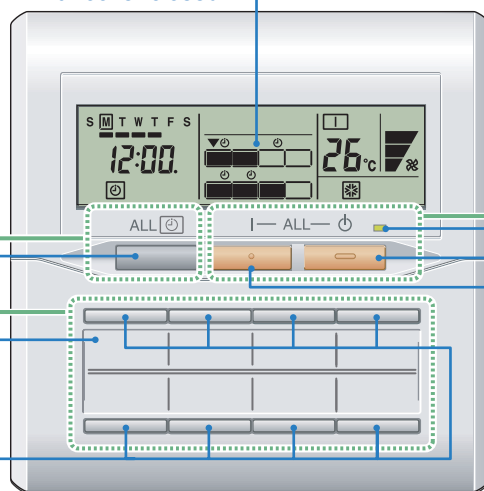

Indoor Unit Operation Indicators

Timer setting at all the connected indoor units is possible by centralized timer on the front panel.

■ : On □ : Off
○ : Timer operation ▼ : Selection

2 All the connected indoor units can be turned on / off simultaneously by centralized ON/OFF button on the front of the cover.

Operation Lamp

This is on if any of the indoor units is operating. This flashes if any of the indoor units has malfunction(s).

ALL OFF Button

Press the ALL OFF button to turn off all of the indoor units.

ALL ON Button

Press the ALL ON button to turn on all of the indoor units.

Timer and Clock Display and setting

With cover open

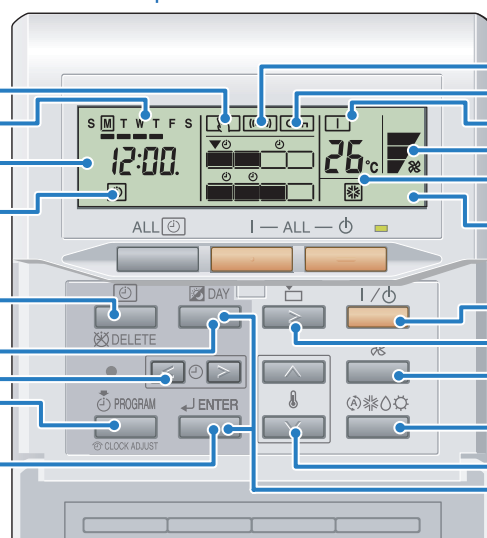

Displaying the Status and Controlling indoor units

- *1 : "AUTO" is not available for a heat pump model unless it is set up for the master indoor unit.
- *2 : "FAN" is not available for a heat pump model
- *3 : "HEAT" is not available for a cooling only model

Specifications

Model name	UTY-CGG*
Power Supply	DC 12V
Dimensions (H x W x D) (mm)	120 x 120 x 17
Weight (g)	200

DC12V is supplied by a network converter.

Touch Panel Controller

UTY-DTG*

7.5 inch screen

High visibility and easy operation via high resolution 7.5 inch TFT-LCD touch panel screen

Stylish design

Stylish shape and design to suit all applications

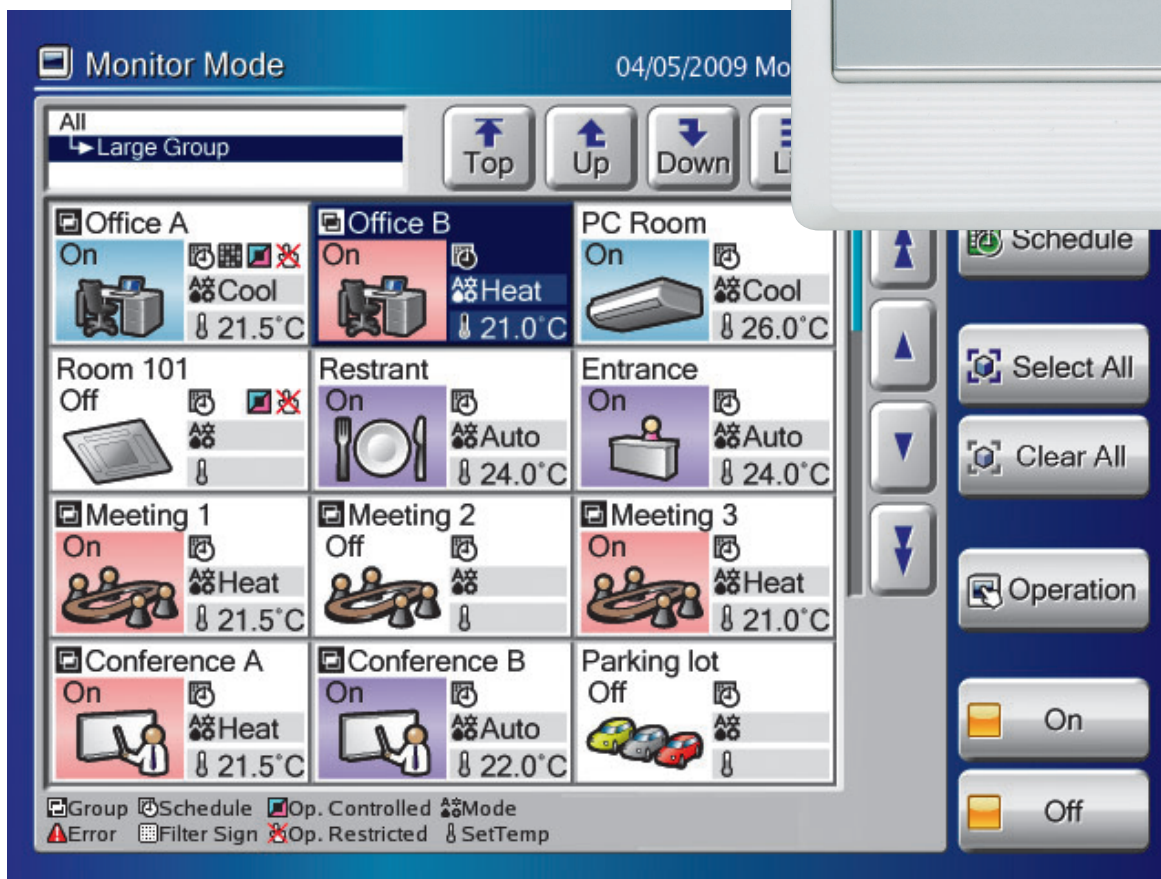

Real size screen image

Easy operation

- Large and wide-angled LCD is easily viewable even at a distance
- Easy-to-understand icon-driven Graphical User Interface (GUI)
- Wide range of simple-to-understand icons
- Operation can be selected using your finger or the dedicated touch pen by pressing the appropriate on-screen icon
- Up-to-date status display
- Background color identifies current control operation
Blue for monitoring, green for operational control



Easy maintenance

- Flat touch screen is easily cleaned
- Non-glare coating on touch panel controller minimizes fingerprint marking
- Easy-to-remove front cover



Up to 400 indoor units can be controlled

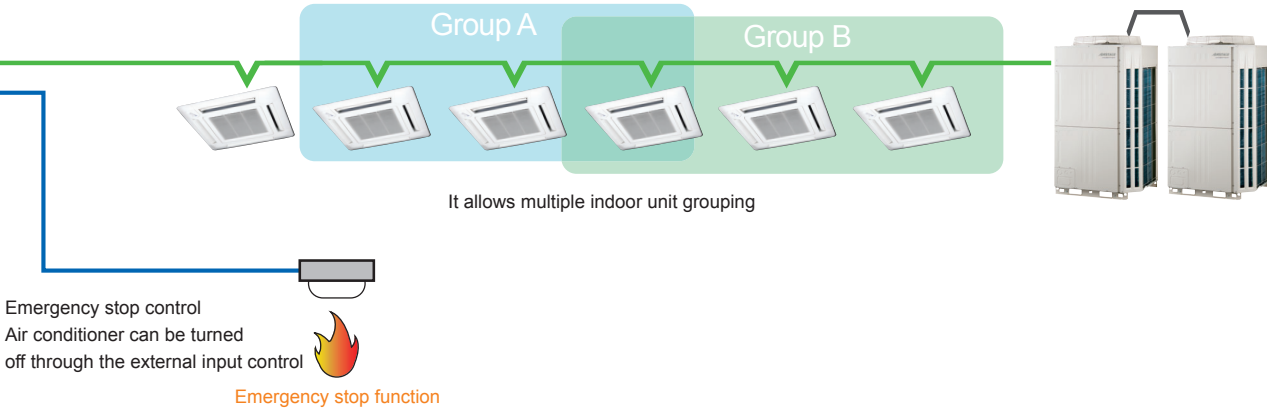

Versatility

Data transfer available by USB

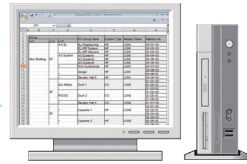

- CSV format data edited by PC can be imported to Touch Panel Controller.

Function

- Up to 400 indoor units can be controlled
- It allows multiple indoor units grouping
- Schedule timer function is standard(20 patterns per day)
- Emergency stop function(through the external input control)
- Temperature upper and lower limit setting
- The clock of each indoor unit correct setting



Individual control



Flexible grouping

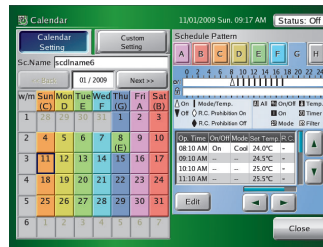

Schedule control

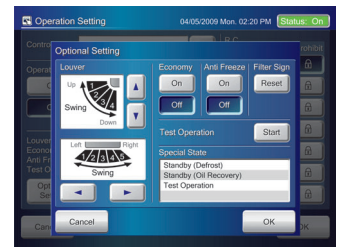

Indoor units operation monitoring

Easy installation

Touch Panel Controller is easily mounted to the wall
Flat back surface allows to be installed wherever it is needed.

- Correctable mechanism for tilting (horizontal) after the installation of the body

No additional component is required for installation

- There is no need for the installation space of power supply adaptor and transmission adaptor etc.



Specifications

Model name	UTY-DTG*
Power Supply	100-240V 50/60Hz
Dimensions (H x W x D) (mm)	260 x 246 x 54
Weight (g)	2,150
Interface	USB 2.0

System Controller

Software

UTY-APGX

This system realizes the advanced general monitoring & control of VRF system from small scale buildings to large scale buildings.

Max. controllable
4
VRF system

Max. controllable
400
outdoor units

Max. controllable
1,600
indoor units

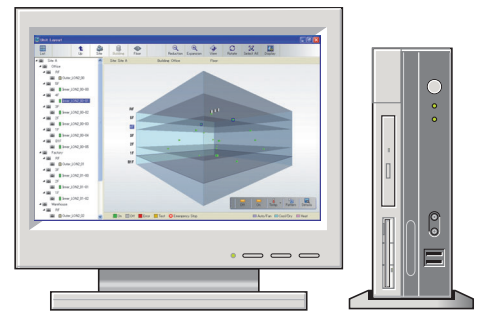

- Up to a maximum of 4 network systems, 1600 indoor units, and 400 outdoor units can be controlled.
- Supports VRF S series, V series and V-II series.
- In addition to air conditioning precision control function, central remote control, electricity charge calculation, schedule management, and energy saving functions are strengthened and building manager and owner needs are met.

Functions

Remote centralized control

System controller may be used on site or remotely over various networks for remote central control. System controller requires 2 softwares working together. Server program runs in the background and communicate with VRF System. Client program provides user interface and communicate with the Server. Server and client program may run in a single PC or in different PCs separated by network. By using client software, one PC can perform central control and web control of 10 VRF system sites with max. 20 buildings per site.

On site central control

Max. 4 network system per site

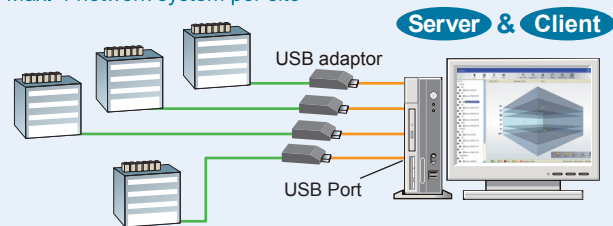

1 network system

Max. controllable	400 Indoor units	100 Outdoor units
-------------------	------------------	-------------------

Max. transmission line length	3,600m
-------------------------------	--------

Remote central control

1 client can control or monitor up to 10 sites.

1 system controller can be monitored from up to 5 clients.

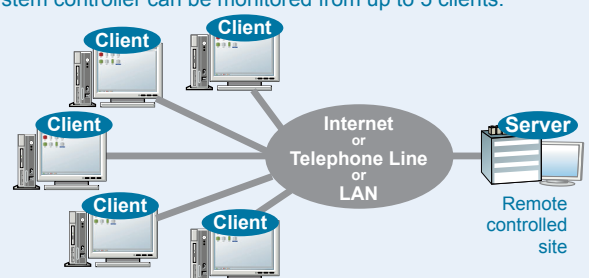
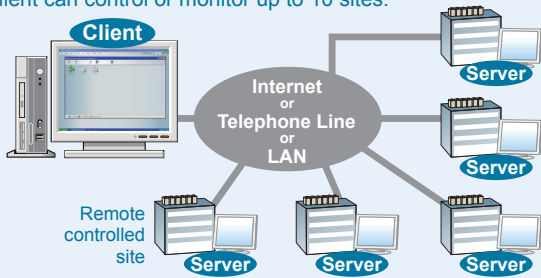

User friendly view and operation

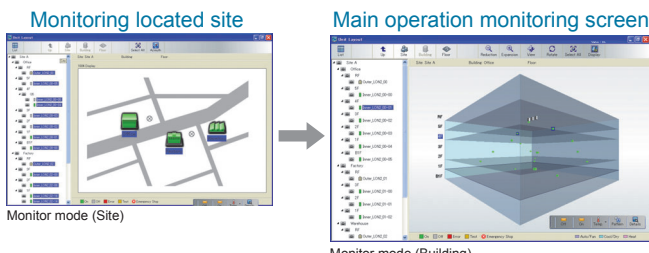

- Provides graphical view of units layout as site, building and floor layout just as they are located in the actual sites.
- Unit status may be monitored at a glance, selecting the appropriate view that just fit your purpose.
- Control may also be performed from various views as individual unit or as a whole site, building or a whole floor.
- User defined groups, that are neatly arrange as tree view, easy to find, monitor and operate.

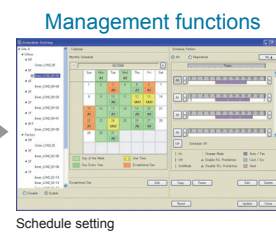
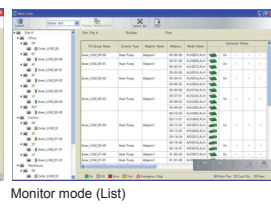
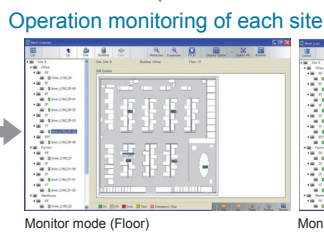
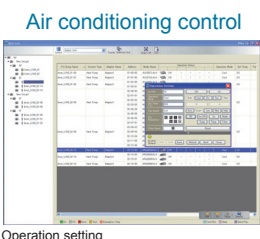

Electricity charge calculation

- Total electricity charge, billed for multiple indoor units connected to the charge meter for air conditioning, is apportioned according to the accumulated operation time and indoor unit capacity.
- Allows accounting for special rates (e.g., for night or weekend use).
- Calculations can be printed as final bills format.

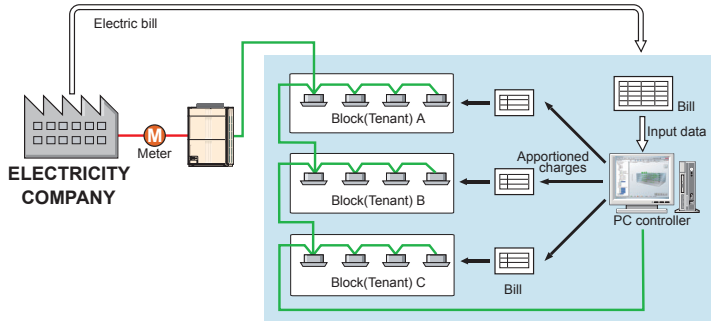

Note: This electrical power apportioning calculation is not official. When issued to the user as a bill, it must be explained to the user in advance.

Schedule control

- Annual schedules can be set for each remote controller group / user defined group.
- Start / stop, operating mode, remote controller prohibition, and temperature settings can be recorded up to 143 times per day at 10 minute intervals for up to 101 configurations for each remote controller group.
- Settings can be made for periods straddling midnight.
- Allows programming of special settings for holidays, including public holidays, for a complete year.

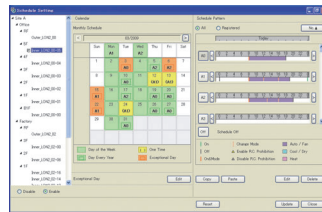

Schedule Control

Error display

Error is notified with popup message, audible sound and e-mail real time when error occurs. Error for the past 1 year are logged and can be reviewed later.

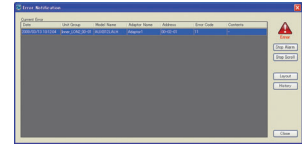

Operating & control record

Displays the history of operation status and control.

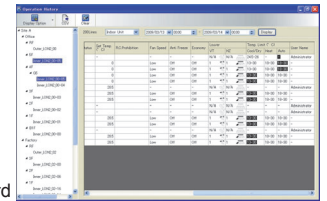

Operation Record

Diverse control of indoor units

- Indoor unit operation state, operation mode, etc. are displayed
- Indoor unit start/stop and operation mode switching
- Temperature setting, Remote Controller prohibition.



Energy saving function

Energy saving operation considering comfort by economy setting, upper/lower limit temperature setting, etc.

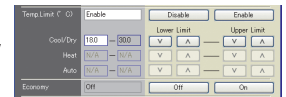

OPERATING CONDITIONS

The following chart shows the detail requirement for an AT compatible personal computer to run System Controller. Applies for both server and client PC.

Personal Computer	AT compatible machine that runs Microsoft® Windows®
Operating System	Microsoft® Windows® Vista Home Premium, Business Edition Microsoft® Windows® XP Professional with Service Pack2 or later
CPU	Intel® Pentium® / Celeron 2GHz (Server), 1GHz (Client) or higher
HDD	40GB or more of free space (5GB for Client PC)
Memory	2GB or more(Server), 1GB or more(Client)
Display	1024 x 768 dots or more. 15 inch or higher size is preferable.
Interface	USB port is required for each of the followings for Server PC; -Wibu Key (Software protection key) - Echelon® U10 USB Network Interface (Required for each VRF Network) Ethernet port is required for remote connection using internet.
Other Software Required	Adobe® Acrobat® reader 4.0 or later
Accelerator	Requires the internal graphics accelerator be compatible with Microsoft® DirectX® 9.0 or later.

<PACKING LIST>

Item	Q'ty	Application
CD-ROM	1	Includes the software for System Controller. Both server and client software is included.
Wibu Key (Software protection key)	1	Software protection key to be inserted in a USB slot running System Controller. System Controller may only run on a PC with Wibu Key. Remote client software does not require Wibu Key.

Personal computer must be field supplied.
U10 USB Network Interface must be field supplied. Contact EchelonR Corporation or its local sales representative for detail.
Product Name : U10 USB Network Interface - TP/FT-10 Channel Model Number: 75010R

Network Converter



UTY-VGGX

- This Network Converter is to be used for connecting single split system or Group Remote Controller (UTY-CGGY/ UTY-CGGG) with the VRF system.
- Please select the function by switching the dip switch during the installation.

Used for connecting single split system

- Split type systems can be centrally controlled from Touch Panel Controller or System Controller through connection to the VRF's network converter.
- On / Off Control, Master control, Room temperature and Fan speed setting via the Network Converter are available.
- One Network Converter can be used to connect and control up to 16 single units.

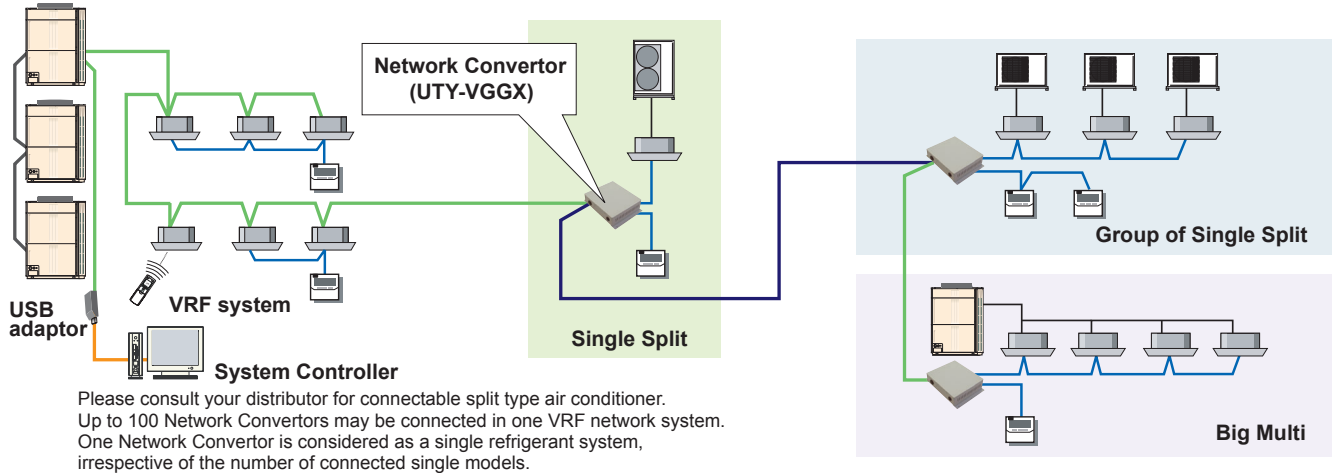

Used for connecting Group Remote Controller

- 4 Group Remote Controllers can be connected to a single Network Converter (UTY-VGGX).

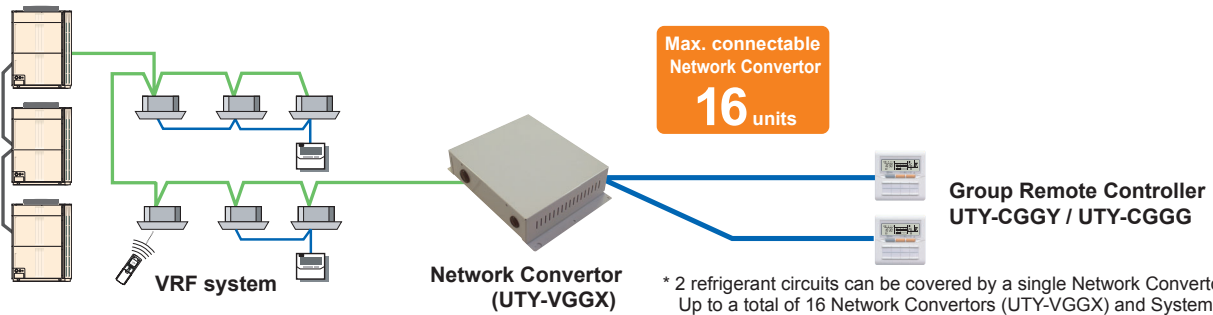

* 2 refrigerant circuits can be covered by a single Network Converter (UTY-VGGX). Up to a total of 16 Network Converters (UTY-VGGX) and System Controller adaptors can be connected in a single VRF system.

Specifications

Model name	UTY-VGGX
Power Supply	220-240V 50/60Hz
Power Consumption (W)	6.5
Dimensions (H x W x D) (mm)	67 x 288 x 211
Weight (g)	1,500

Dimensions

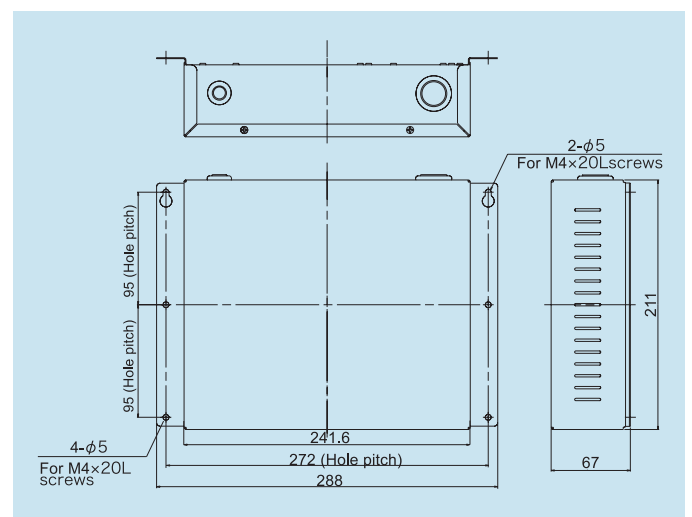

Network Converter for LONWORKS® (Future Release)

UTY-VLGX

Max. controllable
128 units
indoor units



- For connection between VRF system and a LONWORKS® open network for management of small to medium-sized BMS and VRF systems.
- The UTY-VLGX permits central monitoring and control of a VRF system from a BMS through a LONWORKS® interface.
- Up to 128 Indoor units can be connected to one Network Converter for LONWORKS®

Installation example

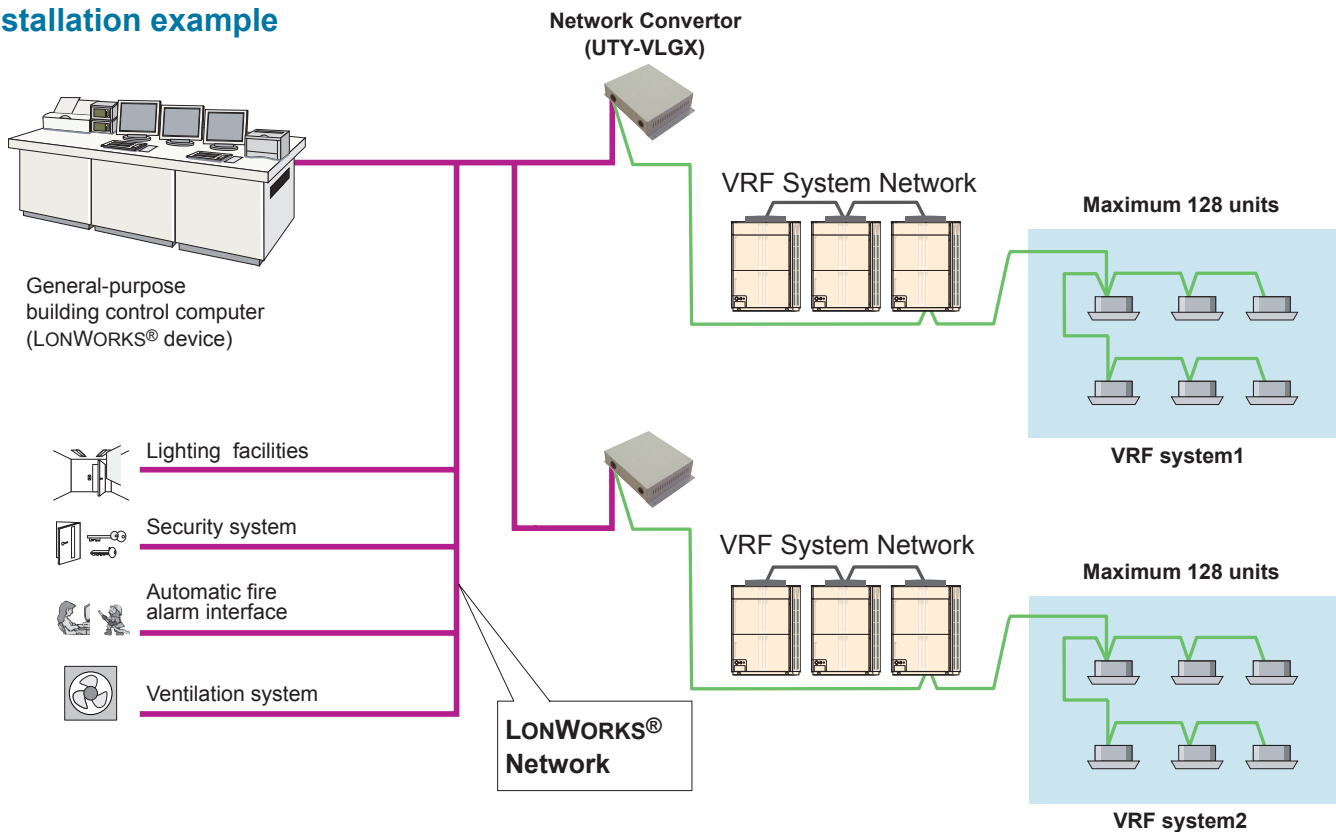

Specifications

Model name	UTY-VLGX
Power Supply	220-240V 50/60Hz
Power Consumption (W)	4.5
Dimensions (H x W x D) (mm)	67 x 288 x 211
Weight (g)	1,500

Dimensions

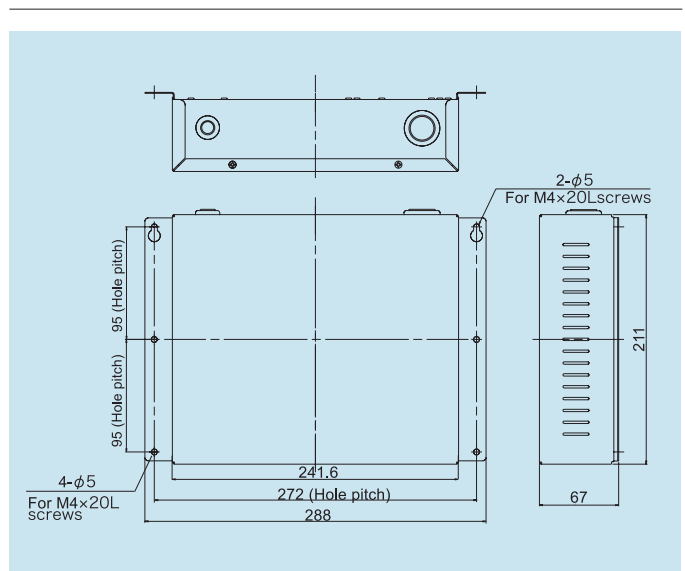

Transmission specifications (BMS side)

Transmission speed	78kbps
Transceiver	FTT-10A
Transmission way form	Free topology
Terminated resistor	None (It attaches at the terminal of a network.)

BACnet® Gateway

Software

(Future Release)

UTY-ABGX

Max. controllable
4
VRF system

Max. controllable
400
outdoor units

Max. controllable
1,600
indoor units

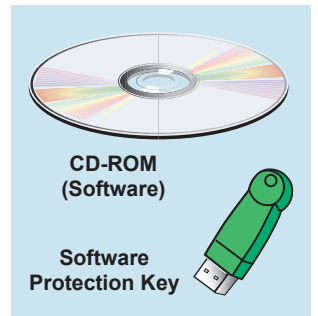

- The VRF system can be incorporated into a Building Management System.
- Enables central control of up to 1,600 indoor units through BACnet®, a global standard for open networks.
- Conforms to ANSI / ASHRAE Standards® 135-2001 BACnet® Application Specific Controller (B-ASC) BACnet® / IP over Ethernet.
- Connects up to 4 VRF systems (1,600 indoor units / 400 outdoor units) per gateway.
- Ideal for applications in high rise buildings and hotels, etc.

Installation example

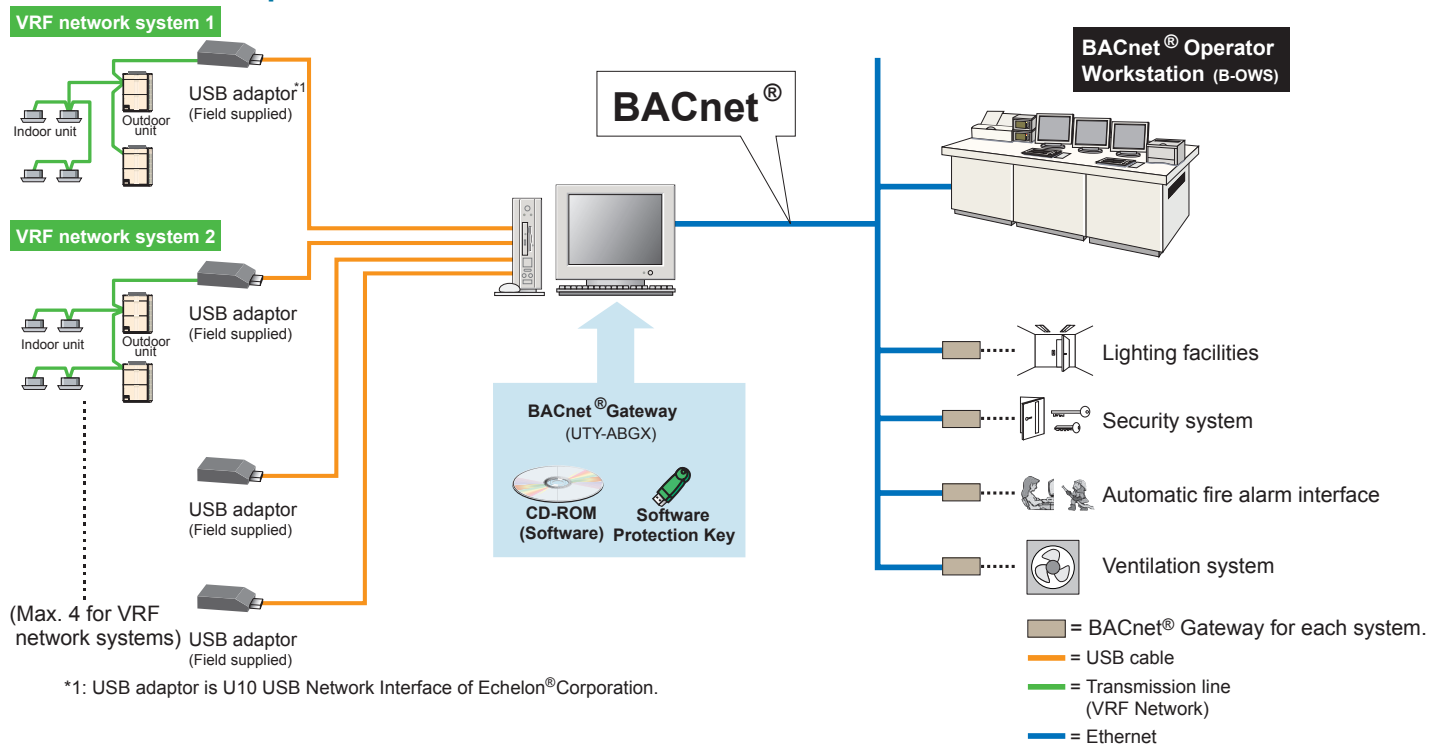

Requirements of PC for this software

Personal Computer	AT compatible machine that runs Microsoft® Windows®
Operating System	Microsoft® Windows® Vista Home Premium, Business, Ultimate Edition Microsoft® Windows® XP Professional with Service Pack2 or later
CPU	Intel® Pentium® / Celeron 2GHz or higher
Memory	1GB (Vista) , 512MB (XP) or more
Display	1024 x 768 dots or more
Interface	USB port is required for each of the followings; -Wibu Key (Software protection key) - Echelon® U10 USB Network Interface (Required for each VRF Network) Ethernet port is required
Other Software Required	Adobe® Acrobat® reader 4.0 or later

<PACKING LIST>

Packing List	CD-ROM / Wibu Key
--------------	-------------------

Signal Amplifier

UTY-VSGX

- Transmission Line length can be extended up to 3,600m with multiple Signal Amplifiers.
- Up to 8 signal amplifiers can be installed in a VRF network system.
- A signal amplifier is required,
 - (1) When the total wiring length of the transmission line exceeds 500m.
 - (2) When the total number of units on the transmission line exceeds 64.



Installation example

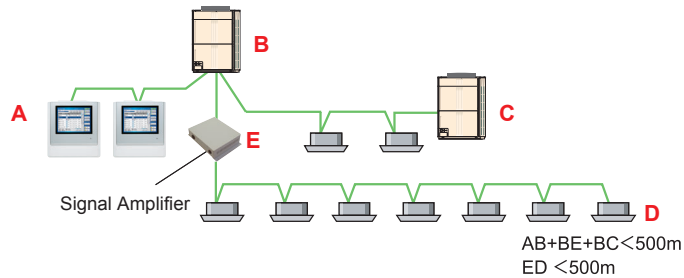

Specifications

Model name	UTY-VSGX
Power Supply	220-240V 50/60Hz
Power Consumption (W)	4.5
Dimensions (H X W X D) (mm)	67 X 288 X 211
Weight (g)	1,500

Dimensions

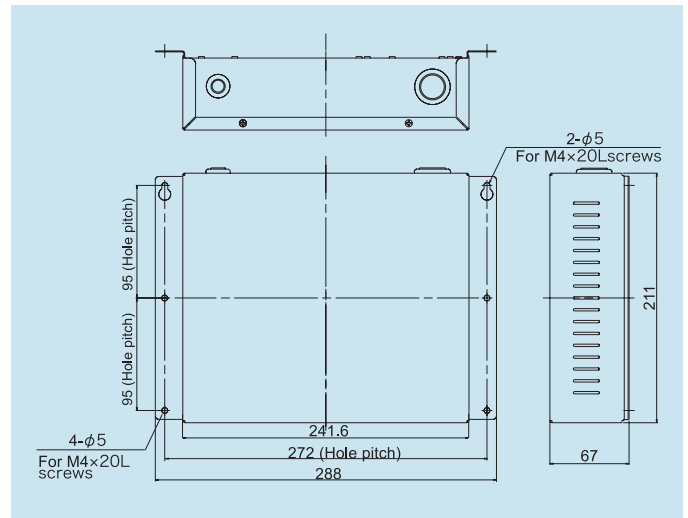

External Switch Controller

UTY-TEKX

Air conditioner switching can be controlled by connecting other sensor switches

- In combination with a field supply Card-Key Switch or other sensor, the External Switch Controller allows control of the ON / OFF, Room temperature, Fan speed and Master control functions. This makes this product suitable for installations such as hotel rooms.
- Card-key or other sensor switches are available as a field supplied parts.

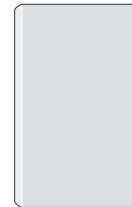

Installation example

- Auto mode operation, which switches the cooling and the heating automatically, is enabled by using the sensor switch and External Switch Controller.
- Note: All indoor units will operate in the same mode.

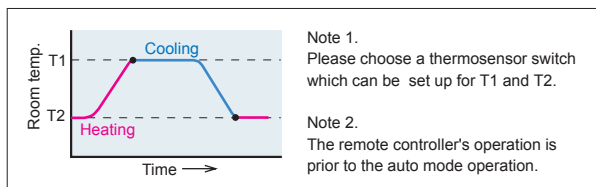

T1 = ON, T2 = OFF

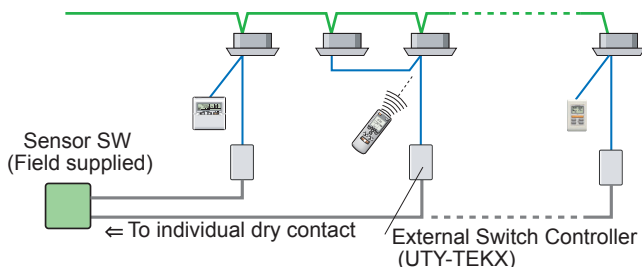

Electrical wiring

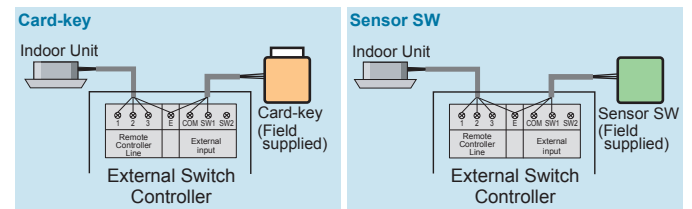

Specifications

Model name	UTY-TEKX
Power Supply	DC 12V
Dimensions (H x W x D) (mm)	120 x 75 x 30
Weight (g)	90

DC12V is supplied by the indoor unit.

Service Tool

Software

UTY-ASGX

Extensive monitoring and analysis functions for installation and maintenance

- Operation status can be checked and analyzed to detect even the smallest abnormalities.
- Storage of data on system operation status on a PC allows access even from off site.
- Up to 400 indoor units (a single VRF system) can be controlled and monitored for large scale buildings or hotels.
- This software can be connected to any point of transmission line with USB adaptor (field supplied)

Max. Monitor and control
100
outdoor units

Max. Monitor and control
400
indoor units



Wiring connection

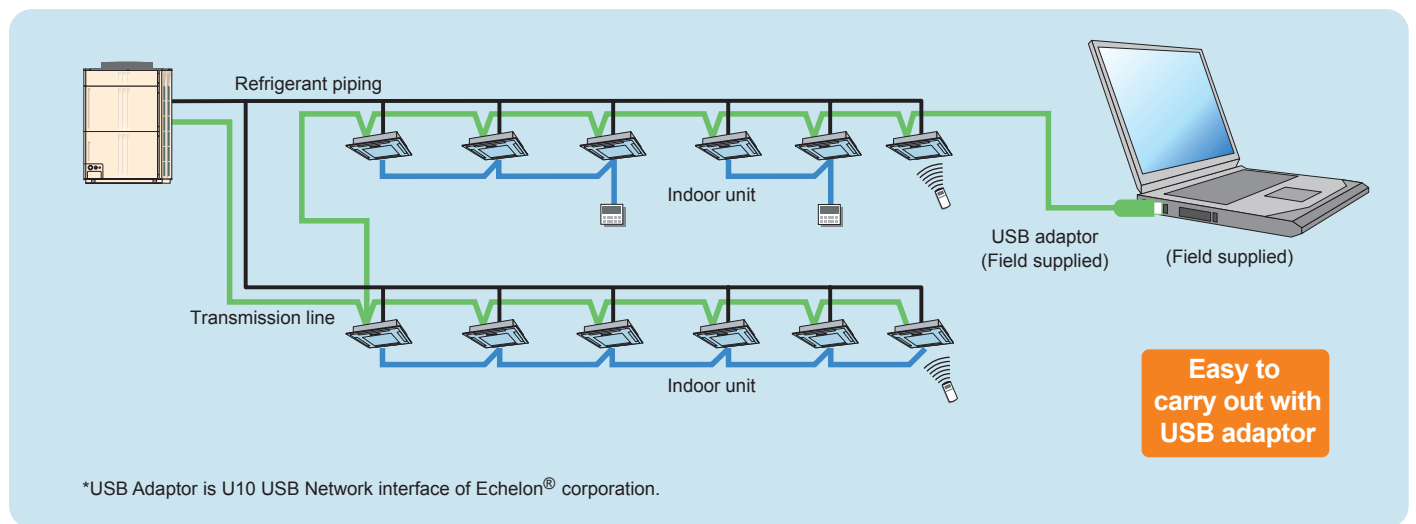

Functions

Equipment Detail (Diagram)

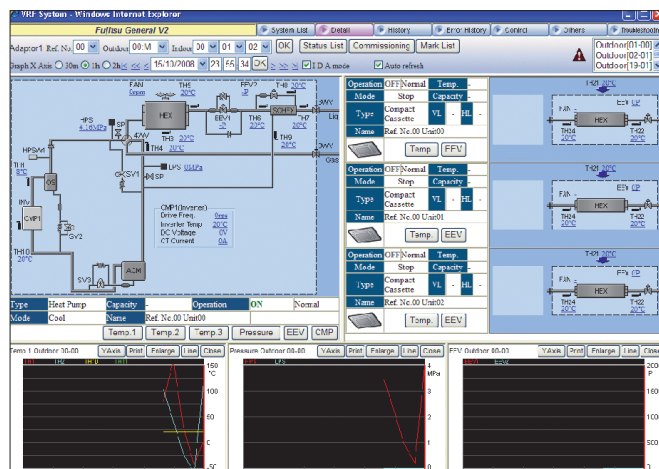

Displays the detail information for sensor values, electrical components etc. for the specified units in schematic. The information here can be used along with the detail information in list form, to check the operation status of units and make detail analysis on the cause, in case an error occurs.

Equipment Detail (List)

Unit	Name	Type	Operation	Special Operation	Mode	TH1	TH2	TH3	TH4	TH5	TH6	TH7	TH8	TH9	TH10	TH11
0034	Ref. No.00 Unit00:04	Cooling Only	ON	-	Cool	23	-26	20	20	20	20	20	20	20	20	20
01S1	Ref. No.00 Unit01:51	Cooling Only	ON	-	Cool	27	-24	20	20	20	20	20	20	20	20	20
02S2	Ref. No.00 Unit02:52	Cooling Only	ON	-	Cool	29	-23	20	20	20	20	20	20	20	20	20

Displays the detail information for sensor values, electrical components etc. of units in a specified refrigerant system in list form. The information here can be used along with the detail information in diagram form, to check the operation status of units and make detail analysis on the cause, in case an error occurs.

Error History

Model	Address Ref	Unit	Name	Error1	Error2	Error3	Error4
Indoor Unit	00	00		18/02/2009 13:16 42.2 Indoor unit Heat Ex Middle temp. sensor error	18/02/2009 13:16 42.1 Indoor unit Heat Ex inlet temp. sensor error		
Indoor Unit	00	63		18/02/2009 13:16 32.3 Indoor unit EEPROM access error	18/02/2009 13:16 32.1 Indoor unit PCB Model information error		
Indoor Unit	01	00		18/02/2009 13:16 12.2 30' send remote controller signal error			
Indoor Unit	01	63		18/02/2009 13:16 12.1 30' send remote controller communication error			
Outdoor Unit	00	00.34		18/02/2009 13:36 72.1 Compressor Temp Sensor 1 Error	18/02/2009 13:34 71.1 Compressor Temp Sensor 1 Error	18/02/2009 13:16 72.2 Compressor Temp Sensor 2 Error	18/02/2009 13:16 72.3 Compressor Temp Sensor 2 Error

Displays the error information for each unit. The error information can sequentially be displayed up to 50 items as they occur starting with the latest error.

System List

Ref.	Unit	R.C.G.	Name	Model	Model Name	Type	Capacity (BTL/h)	Operation	Mode	Set Temp (°C)	Room Temp (°C)	HE.1 In (°C)	HE.1 Out (°C)	HE.1 Fan (°C)	EEV (°F)	Error	
00.34				Out	ATVA73LALH	Heat Pump	-	ON	Cool	-	-	-	-	-	-	0	Normal
01.31				Out	ATVA90LALH	Heat Pump	-	ON	Cool	-	-	-	-	-	-	0	Normal
02.32				Out	ATV106LALH	Heat Pump	-	ON	Cool	-	-	-	-	-	-	0	Normal
00	00			In	AUXB07LALH	Compact Cassette	0	OFF	Stop	-	20	20	20	20	0	0	Normal
01	01			In	AUXB09LALH	Compact Cassette	0	OFF	Stop	-	20	20	20	20	0	0	Normal
02	02			In	AUXB12LALH	Compact Cassette	0	OFF	Stop	-	20	20	20	20	0	0	Normal
03	03			In	AUXB14LALH	Compact Cassette	0	OFF	Stop	-	20	20	20	20	0	0	Normal
04	04			In	AUXB18LALH	Compact Cassette	0	OFF	Stop	-	20	20	20	20	0	0	Normal
05	05			In	AUXB24LALH	Compact Cassette	0	OFF	Stop	-	20	20	20	20	0	0	Normal
06	06			In	AUXD18LALH	Cassette	0	OFF	Stop	-	20	20	20	20	0	0	Normal
07	07			In	AUXD24LALH	Cassette	0	OFF	Stop	-	20	20	20	20	0	0	Normal
08	08			In	AUXC43LALH	Cassette	0	OFF	Stop	-	20	20	20	20	0	0	Normal
09	09			In	AUXC44LALH	Cassette	0	OFF	Stop	-	20	20	20	20	0	0	Normal
10	10			In	AUXC44LALH	Cassette	0	OFF	Stop	-	20	20	20	20	0	0	Normal
11	11			In	AUXC44LALH	Cassette	0	OFF	Stop	-	20	20	20	20	0	0	Normal
12	12			In	ARXB07LALH	Compact Duct	0	OFF	Stop	-	20	20	20	20	0	0	Normal
13	13			In	ARXB09LALH	Compact Duct	0	OFF	Stop	-	20	20	20	20	0	0	Normal

Displays the overall operation status of all or specified units in the system in a list form.

Remote File Download

FileName	Date	Size(KB)
VRF-11F_Ref_48-20050820000-20050820000-040221.gz	25/08/2005 04:03:46	640
VRF-11F_Ref_48-20050820000-20050820000-040621.gz	25/08/2005 04:06:43	520
VRF-11F_Ref_48-20050820000-20050820000-040722.gz	25/08/2005 04:07:48	534
New creating file - VRF-11F_Ref_48-20050820000-20050820000-040753.gz	25/08/2005 04:07:53	
Requesting file - VRF-11F_Ref_48-20050820000-20050820000-040811.gz	25/08/2005 04:08:11	

Operation and error history data can be downloaded. Only the required data may be downloaded specifying the refrigerant system, unit and time range.

Commissioning Tool

Commissioning - Microsoft Internet Explorer

Adaptor: Ref. 07 Cooling Test Heating Test

Outdoor Unit: [00] [01] [02] [03] [04] [05] [06] [07] [08] [09] [10] [11] [12] [13] [14] [15]

Indoor Unit: [16] [17] [18] [19] [20] [21] [22] [23] [24] [25] [26] [27] [28] [29] [30] [31] [32] [33] [34] [35] [36] [37] [38] [39] [40] [41] [42] [43] [44] [45] [46] [47] [48] [49] [50] [51] [52] [53] [54] [55] [56] [57] [58] [59] [60] [61] [62] [63]

Test run commands can be executed with this tool. During test running, the outdoor unit / indoor unit sensor data can be saved (commissioning log data). After the end of test running, this data can be exported in CSV file format.

Requirements of PC for this software

Personal Computer	AT compatible machine that runs Microsoft® Windows®
Operating System	Microsoft® Windows® 2000 Professional (English version / Service pack4 or later) Microsoft® Windows® XP Professional (English version / Service pack2 or later) Microsoft® Windows® Vista Home Premium, Business, Ultimate Edition. (English version)
CPU	Intel® Pentium® / Celeron®, AMD Athlon™ / Duron™ 1GHz or higher
HDD	4.1 GB or more of free space
Memory	1GB (Vista) , 512 MB (XP/2000) or more
Interface	USB port is required for each of the following ; -Wibu Key(Software protection key) -Echelon® U10 USB Network Interface(Required for each VRF Network)
Software	Internet Explorer 6.0 or later / Adobe® Acrobat® Reader 4.0 or later
Hardware	USB Adaptor is U10 USB Network interface of Echelon® corporation.

<PACKING LIST>

Packing List	CD-ROM / Wibu Key
--------------	-------------------

Personal computer must be field supplied.
U10 USB Network Interface must be field supplied. Contact EchelonR Corporation or its local sales representative for detail.
Product Name : U10 USB Network Interface - TP/FT-10 Channel Model Number: 75010R

Web Monitoring Tool Software

UTY-AMGX

4
VRF system
can be supported

1600
Indoor unit
can be monitored

Product features

- Troubleshooting is performed by monitoring each air conditioning unit remotely during periodical system checks.
 - Error notification can be automatically transmitted to several locations using the internet*1.
 - Requires either a dedicated internet connection* or public telephone line.
 - Determination of an error occurrence can be made through error warnings and equipment status information obtained from a remote location.
 - The monitoring data in a remote side can be optionally downloaded. And, this data can be displayed in offline mode of the service tool.
 - Monitoring side computer is not required to install special software, requires only general web browser.
- * 1: USB of internet mail system required.

Web Monitoring System

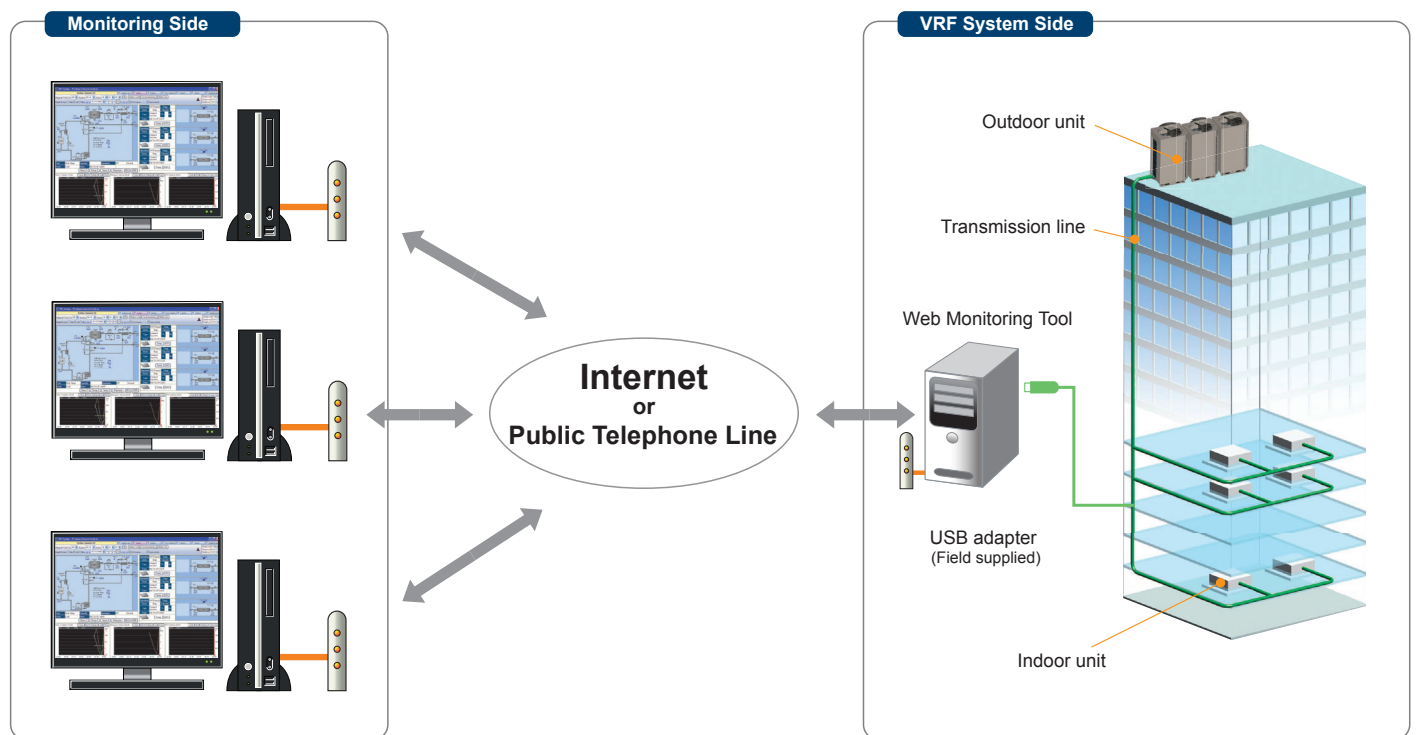

System components

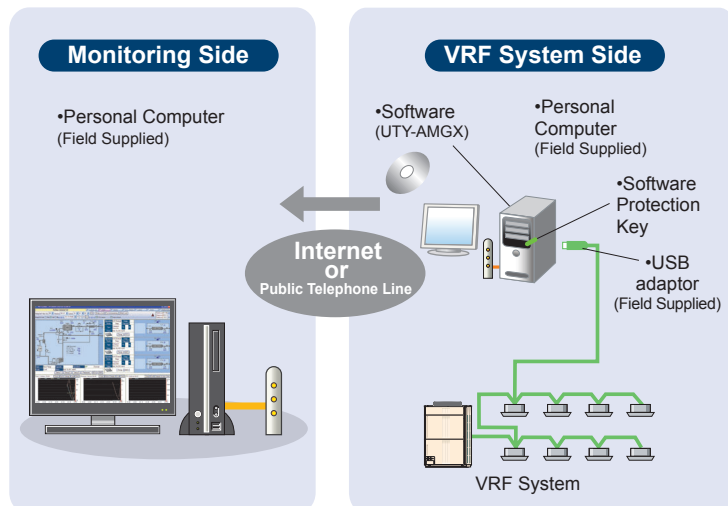

Support 4 VRF system

- USB adaptor (max. 4 adaptors per PC) permit, monitoring of up to 1,600 indoor units.
- Suitable for large-scale buildings or hotels.

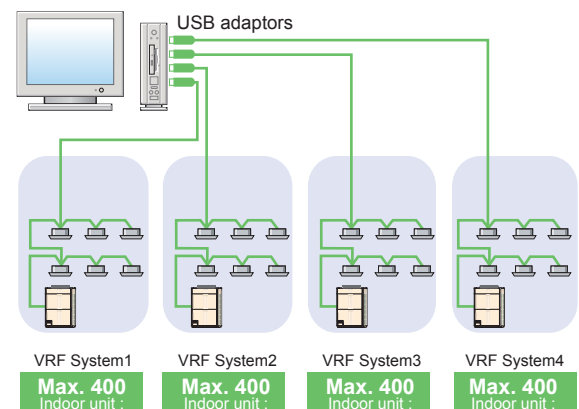

Comparison table

No.	Item	Service Tool UTY-ASGX	Web Monitoring Tool UTY-AMGX	
			Monitoring Side	VRF System Side
1	Interchangeability of equipment	●	●	●
2	Indication of equipment list	●	●	●
3	Operation control	●	—	●
4	Indication of refrigerant circuit diagram	●	●	●
5	Commissioning tool	●	—	●
6	Monitoring of equipment information	●	●	●
7	Monitoring of operating condition	●	●	●
8	Monitoring of sensor data	●	●	●
9	Storage and CSV output of operating history (sensor data)	●	●	●
10	Indication of trend graph	●	●	●
11	Printing of trend graph	●	●	●
12	Monitoring and screen display of abnormalities	●	●	●
13	E-mail automatic transmission of abnormalities	—	—	●*1
14	Setting for user level	—	—	●

*1 Available only during a connection to the Internet.

Requirements of PC for this software

Personal Computer	AT compatible machine that runs Microsoft® Windows®
Operating System	Microsoft® Windows® 2000 Professional (English version / Service pack4 or later) Microsoft® Windows® XP Professional (English version / Service pack2 or later) Microsoft® Windows® Vista Home Premium, Business, Ultimate Edition. (English version)
CPU	Intel® Pentium® / Celeron®, AMD Athlon™ / Duron™ 1GHz or higher
HDD	4.1 GB or more of free space
Memory	1GB or more
Interface	USB port is required for each of the following ; -Wibu Key(Software protection key) -Echelon® U10 USB Network Interface(Required for each VRF Network) Ethernet port is required for remote connection using internet.
Software	Internet Explorer 6.0 or later / Adobe® Acrobat® Reader 4.0 or later
Hardware	USB Adaptor is U10 USB Network interface of Echelon® corporation.

<PACKING LIST>

Packing List	CD-ROM / Wibu Key
--------------	-------------------

Personal computer must be field supplied.

U10 USB Network Interface must be field supplied. Contact EchelonR Corporation or its local sales representative for detail.

Product Name : U10 USB Network Interface - TP/FT-10 Channel Model Number: 75010R

Optional Parts

Connection Tube

Separation Tube

Model : UTR-BP090X

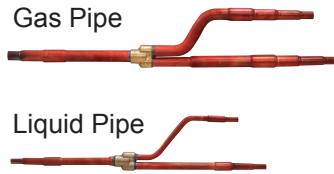

Separation Tube

Model : UTR-BP180X

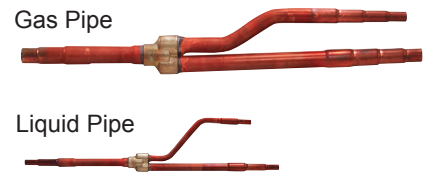

Separation Tube

Model : UTR-BP567X

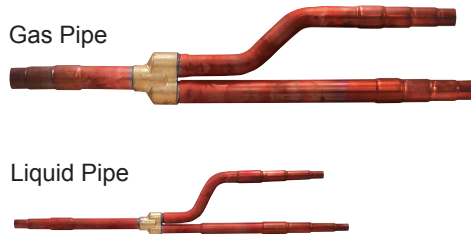

Outdoor Unit Branch kit

Model : UTR-CP567X

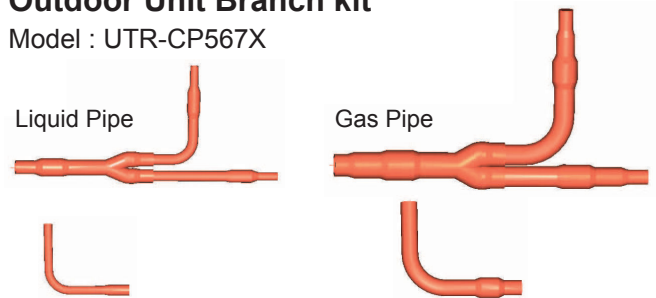

Header

Model : UTR-H0906L
UTR-H1806L

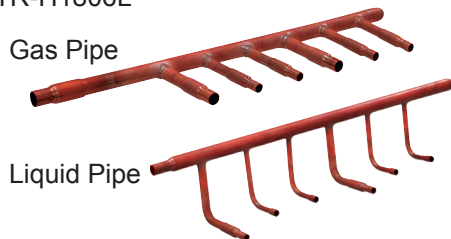

Header

Model : UTR-H0908L
UTR-H1808L

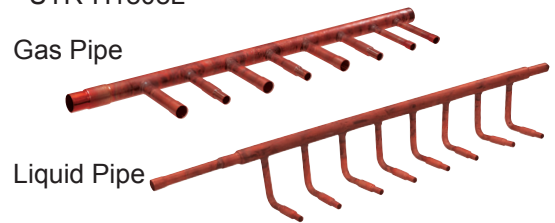

Outdoor unit Branch kit

Model name	UTR-CP567X	
Number of Outdoor unit	2 outdoor units	1
	3 outdoor units	2

Separation Tube

Model name	UTR-BP090X	UTR-BP180X	UTR-BP567X
Total cooling capacity of indoor unit (kW)	28.0 or less	28.1 to 56.0	56.1 or more

Header

Model name	3-6 Branches	UTR-H0906L	UTR-H1806L
	3-8 Branches	UTR-H0908L	UTR-H1808L
Total cooling capacity of indoor unit (kW)	28.0 or less		28.1 to 56.0

EV Kit

Model name	UTR-EV09XB	UTR-EV14XB
Application Model	AS*E07LACH	AS*E12LACH
	AS*E09LACH	AS*E14LACH

AS* : ASY(FUJITSU), ASH(GENERAL)

Others

Flange (Round)

Model : UTD-RF204

For Low Static Pressure Duct type / Duct type



Flange (Square)

Model : UTD-SF045T

For Low Static Pressure Duct type / Duct type



Long-Life Filter

Model : UTD-LF25NA

For Low Static Pressure Duct type/Duct type

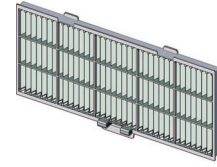

Long-Life Filter

Model : UTD-LF60KA

For High Static Pressure Duct type

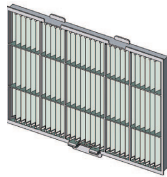

Drain Pump Unit

Model : UTZ-PX1BBA

For Compact Duct type

Model : UTZ-PX1NBA

For Low Static Pressure Duct type and Duct type

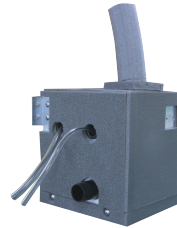

IR Receiver Unit

Model : UTB-YWB

UTB-TWB

For All Duct type



Remote Sensor Unit

Model : UTD-RS100

New amenity space can be offered by installing the Remote sensor in the remote controller.

For All Duct type



Drain Pump Unit

Model : UTR-DPB24T

For Ceiling type

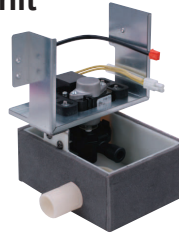

Wide Panel

Model : UTG-AGYA-W

For Cassette type

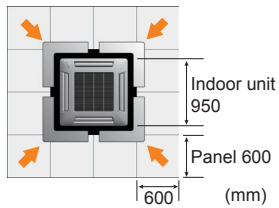

Panel Spacer

Model : UTG-BGYA-W

For Cassette type

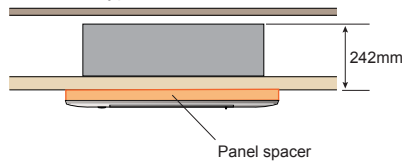

IR Receiver Kit

Model : UTY-LRHYB1

UTY-LRHGB1

For Cassette type



Air Outlet Shutter Plate

Model : UTR-YDZB

Shuts the air outlet when only using as 2 or 3 blow out.

For Cassette type



Air Outlet Shutter Plate

Model : UTR-YDZC

Shuts the air outlet when only using as 2 or 3 blow out.

For Cassette type



Insulation Kit for High Humidity

Model : UTZ-KXGA (For Cassette type)

UTZ-KXGB (For Slim Cassette type)

UTZ-KXGC (For Compact Cassette type)

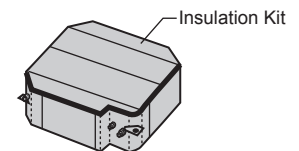

Grille Kit

Model : UTG-UFYC-W

UTG-UFGC-W

For Compact Cassette type



Grille Kit

Model : UTG-UGYA-W

UTG-UGGA-W

For Cassette type



EV Kit

Model code < 09 : UTR-EV09XB

Model code ≥ 12 : UTR-EV14XB

For Compact Wall Mounted type





ISO 9001
Certified number:09 100 79269



ISO 14001
Certified number:104692

Fujitsu General (Shanghai) Co., Ltd.

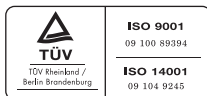

ISO 9001
Certified number:09 100 89394

ISO 14001
Certified number:09 104 9245

Fujitsu General (Thailand) Co., Ltd.

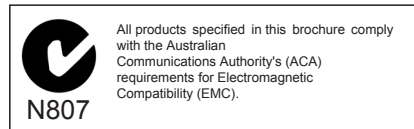

All products specified in this brochure comply with the Australian Communications Authority's (ACA) requirements for Electromagnetic Compatibility (EMC).

"**AIRSTAGE™**" is a worldwide trademark of FUJITSU GENERAL LIMITED and is a registered trademark in Japan, the U.S.A and other countries or areas.

*Microsoft® and Windows® are registered trademarks of Microsoft Corporation in the United States.

*Adobe® and Acrobat Reader® are registered trademarks of Adobe Systems Incorporated in the United States.

*Intel®, Pentium® and Celeron® are registered trademark of Intel Corporation or its subsidiaries in the United States.

*AMD Athlon™ and AMD Duron™ are registered trademark of Advanced Micro Devices, Inc.

*Echelon®, LONWORKS®, and the Echelon logo are trademarks of Echelon Corporation registered in the United States and other countries.

*BACnet® is a registered trademark of the American Society of Heating Refrigeration and Air Conditioning Engineers (ASHRAE).

The colors may be different from the actual colors because this catalog is printed matter.

Product specifications are subject to change without notice.

Distributed by :

Copyright© 2008 Fujitsu General Limited. All rights reserved.

FUJITSU GENERAL LIMITED

1116, Suenaga, Takatsu-ku, Kawasaki 213-8502, Japan
URL : <http://www.fujitsu-general.com>

6NNV22-0905E Printed in Japan